



INSTRUMENTOS CIRÚRGICOS

Catálogo geral de instrumentos cirúrgicos





HISTÓRICO DA EMPRESA

A ABC Instrumentos Cirúrgicos, fundada em 15 de outubro de 1987, surgiu com o objetivo de implantar no mercado um diferencial no ramo de instrumentos cirúrgicos, que necessitava de um atendimento mais competitivo, ágil e personalizado junto aos clientes.

Inicialmente, nos concentramos na fabricação e comercialização de instrumentos voltados para a área cirúrgica em geral, posteriormente com o crescimento contínuo e melhoria organizacional ampliamos nossa área de atuação incluindo em nossa linha de fabricação de instrumentais para: Ginecologia, Buco-Maxilo, Oftalmologia, Cardiovascular, Micro-Cirurgia, Ortopedia, Otorrino, Veterinários e Odontológicos entre outras.

Durante esses mais de 30 anos, adquirimos junto ao Ministério da Saúde, para a empresa e todos os produtos fabricados e distribuídos pela ABC, as certificações e autorizações que se fazem necessárias para reforçarmos nosso compromisso com a qualidade.

Possuimos representantes e distribuidores em todo o Brasil e Mercosul e contamos com uma equipe de vendas e atendimento extremamente profissional e pronta para suprir qualquer necessidade ou dúvida que nossos clientes possam ter. Tudo isso com a tranquilidade de ter mais de 500.000 peças para pronta entrega.

Ao longo destes anos acumulamos diversos títulos de reconhecimento pelo empenho em nosso trabalho, demonstrando responsabilidade para com nossos clientes, fornecedores e colaboradores, como nossas certificações: ISO 9001 e ISO 13485.

Em nossa Home Page estão disponíveis as fotos e informações de todos os nossos produtos para visualização e impressão, além de manuais de conservação e esterilização, catálogo digital para download, catálogo de caixas cirúrgicas e sistema de busca automática de produtos para facilitar sua consulta.

Todo esse trabalho e dedicação foram muito bem recompensados pois temos muito orgulho de reconhecer que a ABC Instrumentos Cirúrgicos tornou-se uma referência de seriedade, comprometimento e acima de tudo, o que realmente importa quando falamos dos nossos produtos e atendimento: **QUALIDADE.**



HISTORY OF THE COMPANY

ABC Instrumentos Cirúrgicos (ABC Surgical Instruments) founded in October 15, 1987; emerged with the purpose of introducing a differential in the surgical instruments market which was in need of a more competitive, agile and personalized attendance to the customers.

In the beginning, we focused on the manufacture and commercialization of the instruments destined for the surgical area in general, afterwards with the continuous growth and organizational improvement, we expanded our performance area, including in our production line, the manufacture of instruments to: gynecology, oral and maxillofacial, ophthalmology, cardiovascular, micro-surgery, orthopedics, otorhinolaryngology, veterinary, odontology and others.

During more than 30 years of work, we've obtained from the Health Ministry, for the company and all of our products, all the certifications and authorizations required to strengthen our commitment to quality.

We've got representatives and distributors all over Brazil and Mercosul and we have a sales and attendance team extremely professional and ready to fulfill any requirements our clients may have. All of this with the tranquility of having more than 500.000 pieces in stock to prompt delivery.

We've been accumulating certification in recognition of the determination in our work, showing our responsibility to our clients, suppliers and collaborators, as our ISO 9001 and ISO 13485 certifications.

On our homepage the photos and information of all our products are available to be visualized and printed, besides the conservation and sterilization manual, digital catalogue for download, surgical box catalogue and an automatic searching system of our products to facilitate your search.

All this hard work and commitment has brought many rewards, nowadays we are proud to recognize that ABC has become a reference of commitment, responsibility and above everything, what really matters when we talk about our products and customer service: **QUALITY**



HISTÓRICO DE LA EMPRESA

ABC Instrumentos Cirúrgicos (ABC Instrumentos Quirúrgicos) fue fundada en 15 de octubre de 1987 y surgió con el objetivo de implantar en el mercado un diferencial en el ramo de instrumentos quirúrgicos, que necesitaba una atención más competitiva, ágil y personalizada junto a los clientes.

Al principio, nos concentramos en la fabricación y la comercialización de instrumentos para el área quirúrgica en general, enseguida con el crecimiento y una mejor organización ampliamos nuestro campo de actuación incluyendo en nuestra línea de fabricación instrumentos para: Ginecología, Buco-Maxilo, Oftalmología, Cardiovascular, Micro-quirugía, Ortopedia, Otorrinolaringología, Veterinaria y Odontología.

Junto al Ministerio de la Salud, conseguimos para la empresa y para todos los productos fabricados y repartido por ella, las certificaciones y autorizaciones que son necesarias para fortalecer nuestro compromiso con la calidad.

Tenemos representantes y distribuidores por todo Brasil y Mercosur, también contamos con un equipo de ventas y servicio a los clientes extremadamente profesional y lista para atender a cualquier necesidad que nuestros clientes puedan tener. Todo eso con la tranquilidad de poder contar con un acopio de más de 500.000 piezas para pronta entrega.

A lo largo de estos años, conseguimos diversos títulos de reconocimiento por nuestro compromiso en el trabajo, demostrando responsabilidad con nuestros clientes, proveedores y colaboradores, como nuestras certificaciones ISO 9001 y ISO 13485.

En nuestra página Web están disponibles fotos y informacione de todos nuestros productos para visualización e impresión, además de guías de conservación y esterilización, catalogo digital de productos para download, catalogos de cajas quirúrgicas, lista de precios y un sistema de búsqueda automática de productos para facilitar su consulta.

Todo ese trabajo y dedicación fueron muy bien recompensados pues estamos muy orgullosos de reconocer que la ABC Instrumentos Quirúrgicos se ha convertido una referencia de seriedad, compromiso y sobre todo, lo que realmente importa cuando hablamos de nuestros productos y atención al cliente: CALIDAD.



ABE

ÍNDICE

INDEX

ÍNDICE





ÍNDICE	Página
A	
ABAIXADORES DE LÍNGUA	
BRUENINGS	18
ABRIDORES DE BOCA	
JENNINGS	18
MC-IVOR	18
MOLT	18
WHITEHEAD	18
ABRIDORES DE GESSO	
HENNING	19
WOLFF	19
AFASTADORES	
ADSON-BABY	19
ALM	19
AUFRICTH	19
BAUFOUR	19/20
BECKMAN ADSON	20
BENNET	20
CASTROVIEJO	20
DESMARRES	20
FARABEUF	20
FINOCHIETTO	21
GELPI	21
GOSSET	21
HENLEY	21
HOHMANN	21
ISRAEL	21/22
KOCHER	22
LANGENBECK	23
LOVE	23
MEAD	24
MILLIN	24
OLLIER	24
RICHARDSON	24
SEN-MULLER	24
VOLKMANN	25/26
WEITLANER	26
AGULHAS	
LUCAE	26/27
OBWEGESER	27
ALICATES	
CORTE LATERAL	27
ANUSCÓPIOS	
BENSAUDE	27
PITANGA	27
ASPIRADORES	
YANKAUER	28

ÍNDICE	Página
B	
BISTURI	
ABRAHAM	28
BRUENINGS	28
ESMARCH	28
BLEFAROSTATO	
BARRAQUER	28
CASTROVIEJO	28
COOK	29
PARK	29
C	
CABO	
CABO INTERMEDIÁRIO	29
CABO P/ BISTURI	29/30
CABO P/ ESPELHO DE LARINGE	30
CABO P/ SERRA DE GIGLI	30
CÂNULA	
BALIU	30
FRAZIER	30
CAUTERIO	
WADSWORTH-TOOD	30
CIZALHAS	
LISTON	31
LUER	31
RUSKIN LISTON	32
SEMB	32
STILLE LISTON	32
STILLE LISTON KEY	33
STILLE LUER	33
STILLE P/ GESSO	33
CLIPS	
MAYO	33
COSTOTOMOS	
COLLIN	33
GLUCK	34
COSTOTOMO MOD. SIMPLES	34
SAUERBRUCH	34
CRANEOCLASTO	
BRAUM	34
CURETAS	
BRUNS	34
NOVAK	35
MEYHOEFER	35
RECAMIER	35
SCHROEDER	35



ÍNDICE	Página
CURETAS	
WALLICH	36
WILLIGER	36
D	
DESCOLADORES	
COLVER	36
HURD	36
DILATADORES	
DESJARDIM	36
LA-BORDE	36
SIMS	37
TROUSSEAU	37
VELA DE HEGAR	37
WYLIE	37
E	
ESPÁTULAS	
FLEXÍVEL	37
REVERDIN	38
TUFFIER	38
ESPECÍMETROS	
IWANSON	38
ESPÉCULOS	
AURICULAR DE HARTMANN	38
AURICULAR DE POLITZER	38
COLLIN	39
KILLIAN	39
MATHIEU	39
HARTMANN	39
PITANGA SANTOS	40
SIMS	40
ESTILETES	
BIOLIVAR	40
ESTILETE P/ ALGODÃO	40
F	
FACAS	
BALLENGER	40
BECKMAN	40
CATLIN	41
COLLIN	41
FLEBOEXTRATOR	
FLEBOEXTRATOR	41
FORCEPS	
AUXILIAR P/ PARTO	41
KIELAND	41
LEE	41
PIPER	42

ÍNDICE	Página
SIMPSON	42
FORMÃO	
LAMBOTTE	42
STILLE	42
G	
GANCHOS	
BRAUM	43
GILLIES	43
HARTMAN	43
JOSEPH	43
MODENHAUER	43
ZALFAL	43
H	
HISTERÔMETROS	
COLLIN	44
SIMS	44
M	
MARTELOS	
BABINSKI	44
BUCK	44
DEJERINE	44
HAJEK	45
MEAD	45
NEUFIELD	45
TEYLOR	45
UNIVERSAL	45
WILLIGER	45
MENISCÓTOMOS	
SMILLIE	46
P	
PELVIMETROS	
COLLIN	46
MARTIN	46
PERFURADORES	
HUDSON	46
SMELLIE	47
PINÇAS	
ABADIE	47
ADSON	47
ADSON BROWN	47
ALLIS	47
ANATÔMICA DISSECÇÃO	48
ANATÔMICA DENTE DE RATO	48
ANATÔMICA PONTA FINA	48
ASCH	48
AUTO CENTRANTE	48
AUXILIAR DE SUTURA	48



ÍNDICE	Página
PINÇAS	
BABCOCK	49
BACKHAUS	49
BERNHARD	49
BEYER	49
BISHOP	49
BOZEMANN	50
BRUENINGS	50
BULDOG	50
CHERON	50
CHEVALIER	50/51
CITELLI	51
CLAMP	51
CLÍNICA P/ ALGODÃO	51
COLIBRI BARRAQUER	51
COLLIN CORAÇÃO	51
COLLIN P/ CURATIVO	52
COLLIN P/ INSTRUMENTOS	52
COLLIN OVAL	52
COTTLE WALSHAM	52
CRAFOORD	53
CRILE	53
CUSHING	53
DANDY	54
DARTIGUES	54
DE - BAKEY	54
DOYEN P/ CAMPO	54
DOYEN - ATRAUMA	54
DOYEN INTESTINAL E COPROSTASI	55
DUCK BILL	55
DUVAL	55
FARABEU F LAMBOTTE	55/56
FARABEU F VAN-BUREN	56
FAURE	56
FERGUSSON	56
FERRIS SMITH KERRISON	56/57
FOERSTER	57
GLOVER	57
GRUENWALD	58
GUYON	58
HALSTEAD MOSQUITO	58
HARTMANN MICRO	59
HARTMANN P/ CURATIVO	59
HARTMANN P/ CORPO ESTRANHO	59/60
HISTOLOGICA	60
JONES	60
KELLY	60
KERRISON	61
KOCHER HEMOSTATICA	61
KOCHER INTESTINAL E COPROSTASI	61
KOCHER - ATRAUMA	61/62
LAMBOTTE	62
LANE	62
LEKSELL	62
LOWMANN	62

ÍNDICE	Página
LUCAE	63
LUER SIMPLES	63
LUER DUPLA ARTICULAÇÃO	63
MAGIL	63
MARTIN	64
MATHIEU	64
MENKEN OU KOGAN	64
MICHEL	64
MARTEL	64
MIXTER	65
MOYNIHAN	65
MUSEUX	65
NELSON	65
PINÇA P/ BIOPSIA MICRO	65/66
PATA DE GATO	66
PAYR	66
PEAN	66
PELKMANN	67
PENNINGTON	67
PERRY	67
POZZI	67
PROFESSOR MEDINA	67
RANDALL	67
REINOLD	68
ROCHESTER CARMALT	68
ROCHESTER PEAN	68
ROMPE BOLSA	68
ROWE	69
RUSKIN	69
SATINSKY	69
SCHIMIDT	70
SCHUBERT	70
SCHUMACHER	70
SEMB	70
SNELLEN	70/71
TAKAHASHI	71
THOMAS GAYLOR	71
TROELTSCH	71
YEOMAN	71/72
WERTHEIM-CULLEN	72
WINTER	72
PORTA - AGULHAS	
CASTROVIEJO	72/73
CRILE WOOD	73
DERF	73
ERMOLD	73
MATHIEU	73
MAYO HEGAR	74
PORTA AGULHA P/ FIO DE AÇO	74
PORTA - AGULHA DE TUNGSTÊNIO	
GILLIES	74
MAYO HEGAR	74
MATHIEU	74



ÍNDICE	Página
PORTA - AGULHA DE TUNGSTÊNIO	
OLSEN HEGAR	74
PORTA GILETE	
CASTROVIEJO	75
PUNCH	
KEYS	75
R	
RASPAS	
AUFRICHT	75
COTTLE	75
LEWIS	76
RETOSCÓPIO	
PITANGA	76
ROTATIVA	
BALIU	76
RUGINAS	
DOYEN	76
FARABEU	77
LAMBOTTE	77
S	
SACA FIBROMA	
DOYEN	77
SERRAS	
CHARRIERE	77
GIGLI	77
JOSEPH	78
LANGENBECK	78
MATHIEU	78
WEISS	78
WIGMORE	78
SERRA NÓ	
BRUENINGS	79
SONDAS	
ITARD	79
TENTACANULA	79
T	
TESOURAS	
BALIU	79
BARRAQUER	79
BELLUCCI	79/80
CASTROVIEJO	80
CIRÚRGICA	80/81
ENTERÓTOMO	81
GOLDMAN FOX	81

ÍNDICE	Página
HEYMANN	82
IRIS OU GENGIVA	82
JOSEPH	82
KILNER	82
LISTER	83
MAYO STILLE	83
METZEMBAUM	83
NOYES IRIS	84
OURO	84
POTTS - SMITH	84/85
SCHUMACHER	85
SIMS	85
SMITH	85
SPENCER	85
STEVENS	86
TESOURA P/ CORDÃO UMBILICAL	86
VANNAS	86
WESTCOTT	86/87
V	
VALVULAS	
AUVARD	87
DOYEN	87
DOYEN SUB-PUBIANA	87
VALVULA P/ AFASTADOR BAUFOR	87



INSTRUMENTOS CIRÚRGICOS

www.abcinstrumentos.com.br



INDEX	Pages
A	
ANOSCOPES	
BENSAUDE	27
PITANGA	27
B	
BONE CHISELS	
LAMBOTTE	42
STILLE	42
BONE CUTTING FORCEPS	
LISTON	31
LUER	31
RUSKIN LISTON	32
SEMB	32
STILLE LISTON	32
STILLE LISTON KEY	32
STILLE LUER	32
STILLE P/ GESSO	32
C	
CANNULA	
BALIU	30
FRAZIER	30
CAUTER	
WADSWORTH-TOOD	30
CRAINOCLAST	
BRAUM	34
CURETTES	
BRUNS	34
NOVAK	35
MEYHOEFER	35
RECAMIER	35
SCHROEDER	35
WALLICH	36
WILLIGER	36
D	
DILATORS	
DESJARDIM	36
LA-BORDE	36
SIMS	37
TROUSSEAU	37
VELA DE HEGAR	37
WYLIE	37
E	
EYES SPECULUM	
BARRAQUER	28
CASTROVIEJO	28
COOK	29

INDEX	Pages
PARK	12
F	
FORCEPS	
ABADIE	47
ADSON	47
ADSON BROWN	47
ALLIS	47
ANATÔMICA DISSECÇÃO	48
ANATÔMICA DENTE DE RATO	48
ANATÔMICA PONTA FINA	48
ASCH	48
AUTO CENTRANTE	48
AUXILIAR DE SUTURA	48
BABCOCK	49
BACKHAUS	49
BERNHARD	49
BEYER	49
BISHOP	49
BOZEMANN	50
BRUENINGS	50
BULDOG	50
CHERON	50
CHEVALIER	50/51
CITELLI	51
CLAMP	51
CLÍNICA P/ ALGODÃO	51
COLIBRI BARRAQUER	51
COLLIN CORAÇÃO	51
COLLIN P/ CURATIVO	52
COLLIN P/ INSTRUMENTOS	52
COLLIN OVAL	52
COTTLE WALSHAM	52
CRAFOORD	53
CRILE	53
CUSHING	53
DANDY	54
DARTIGUES	54
DE - BAKEY	54
DOYEN P/ CAMPO	54
DOYEN - ATRAUMA	54
DOYEN INTESTINAL E COPROSTASI	55
DUCK BILL	55
DUVAL	55
FARABEUF LAMBOTTE	55/56
FARABEUF VAN-BUREN	56
FAURE	56
FERGUSON	56
FERRIS SMITH KERRISON	56/57
FOERSTER	57
GLOVER	57
GRUENWALD	58
GUYON	58
HALSTEAD MOSQUITO	58
HARTMANN MICRO	59

INDEX	Pages
FORCEPS	
HARTMANN P/ CURATIVO	59
HARTMANN P/ CORPO ESTRANHO	59/60
HISTOLOGICA	60
JONES	60
KELLY	60
KERRISON	61
KOCHER HEMOSTATICA	61
KOCHER INSTESTINAL E COPROSTASI	61
KOCHER - ATRAUMA	61/62
LAMBOTTE	62
LANE	62
LEKSELL	62
LOWMANN	62
LUCAE	63
LUER SIMPLES	63
LUER DUPLA ARTICULAÇÃO	63
MAGIL	63
MARTIN	64
MATHIEU	64
MENKEN OU KOGAN	64
MICHEL	64
MARTEL	64
MIXTER	65
MOYNIHAN	65
MUSEUX	65
NELSON	65
PINÇA P/ BIOPSIA MICRO	65/66
PATA DE GATO	66
PAYR	66
PEAN	66
PELKMANN	67
PENNINGTON	67
PERRY	67
POZZI	67
PROFESSOR MEDINA	67
RANDALL	67
REINOLD	68
ROCHESTER CARMALT	68
ROCHESTER PEAN	68
ROMPE BOLSA	68
ROWE	69
RUSKIN	69
SATINSKY	69
SCHIMIDT	70
SCHUBERT	70
SCHUMACHER	70
SEMB	70
SNELLEN	70/71
TAKAHASHI	71
THOMAS GAYLOR	71
TROELTSCH	71
YEOMAN	71/72
WERTHEIM-CULLEN	72
WINTER	72

INDEX	Pages
FORCEPS HOLDER	
MAYO	33
H	
HAMMERS	
BABINSKI	44
BUCK	44
DEJERINE	44
HAJEK	45
MEAD	45
NEUFIELD	45
TEYLOR	45
UNIVERSAL	45
WILLIGER	45
HANDLE	
CABO INTERMEDIÁRIO	29
CABO P/ BISTURI	29/30
CABO P/ ESPELHO DE LARINGE	30
CABO P/ SERRA DE GIGLI	30
HOOKS	
BRAUM	43
GILLIES	43
HARTMAN	43
JOSEPH	43
MODENHAUER	43
ZALFAL	43
K	
KNIFE	
BALLENGER	40
BECKMAN	40
CATLIN	41
COLLIN	41
KNOT SAW	
BRUENINGS	79
M	
MEASURING INSTRUMENTS	
IWANSON	38
MENISCOTOMES	
SMILLIE	46
MOUTH GAGS	
JENNINGS	18
MC-IVOR	18
MOLT	18
WHITEHEAD	18
MYOMA SCREW	
DOYEN	77

INDEX	Pages
N	
NASAL RASPS	
AUFRICHT	75
COTTLE	75
LEWIS	76
NEEDLES	
LUCAE	26/27
OBWEGESER	27
NEEDLE - HOLDERS	
CASTROVIEJO	72/73
CRILE WOOD	73
DERF	73
ERMOLD	73
MATHIEU	73
MAYO HEGAR	74
PORTA AGULHA P/ FIO DE AÇO	74
NEEDLE - HOLDERS TUNGSTEN CARBIDE	
GILLIES	74
MAYO HEGAR	74
MATHIEU	74
OLSEN HEGAR	74
O	
OBSTETRICAL FORCEPS	
AUXILIAR P/ PARTO	41
KIELAND	41
LEE	41
PIPER	42
SIMPSON	42
P	
PELVIMETERS	
COLLIN	46
MARTIN	46
PERFORATORS	
HUDSON	46
SMELLIE	47
PERIOSTEAL RASPATORIES	
DOYEN	76
FARABEUF	77
LAMBOTTE	77
PLASTER CAST SPREADER	
HENNING	19
WOLFF	19
PLIERS	
CORTE LATERAL	27

INDEX	Pages
PROBES	
ITARD	79
TENTACANULA	79
PUNCH	
KEYS	75
R	
RAZOR BLADE HOLDERS	
CASTROVIEJO	75
RECTAL SPECULA	
PITANGA	76
RETRACTORS	
ADSON-BABY	19
ALM	19
AUFRICHT	19
BAUFOUR	19/20
BECKMAN ADSON	20
BENNET	20
CASTROVIEJO	20
DESMARRES	20
FARABEUF	20
FINOCHIETTO	21
GELPI	21
GOSSET	21
HENLEY	21
HOHMANN	21
ISRAEL	21/22
KOCHER	22
LANGENBECK	23
LOVE	23
MEAD	24
MILLIN	24
OLLIER	24
RICHARDSON	24
SEN-MULLER	24
VOLKMANN	25/26
WEITLANER	26
RIB SHEARS	
COLLIN	33
GLUCK	34
COSTOTOMO MOD. SIMPLES	34
SAUERBRUCH	34
S	
SAWS	
CHARRIERE	77
GIGLI	77
JOSEPH	78
LANGENBECK	78
MATHIEU	78

INDEX	Pages
SAWS	
WEISS	78
WIGMORE	78
SCALPELS	
ABRAHAM	28
BRUENINGS	28
ESMARCH	28
SCISSORS	
BALIU	79
BARRAQUER	79
BELLUCCI	79/80
CASTROVIEJO	80
CIRÚRGICA	80/81
ENTERÓTOMO	81
GOLDMAN FOX	81
HEYMANN	82
IRIS OU GENGIVA	82
JOSEPH	82
KILNER	82
LISTER	83
MAYO STILLE	83
METZEMBAUM	83
NOYES IRIS	84
OURO	84
POTTS - SMITH	84/85
SCHUMACHER	85
SIMS	85
SMITH	85
SPENCER	85
STEVENS	86
TESOURA P/ CORDÃO UMBILICAL	86
VANNAS	86
WESTCOTT	86/87
SPATULAS	
FLEXÍVEL	37
REVERDIN	38
TUFFIER	38
SPECULUM	
AURICULAR DE HARTMANN	38
AURICULAR DE POLITZER	38
COLLIN	39
KILLIAN	39
MATHIEU	39
HARTMANN	39
PITANGA SANTOS	40
SIMS	40
STYLET	
BIOLIVAR	40
ESTILETE P/ ALGODÃO	40

INDEX	Pages
SUCTION TUBES	
YANKAUER	28
T	
TONGUE DEPRESSOR	
BRUENINGS	18
TONSIL DISSECTOR	
COLVER	36
HURD	36
U	
UTERINE BIOPSY CURETTES	
BALIU	76
UTERINE SOUND	
COLLIN	44
SIMS	44
V	
VALVES	
AUVARD	87
DOYEN	87
DOYEN SUB-PUBIANA	87
VALVULA P/ AFASTADOR BAUFOR	87
VEIN PROBE SET	
FLEBOEXTRATOR	41



INSTRUMENTOS CIRÚRGICOS

www.abcinstrumentos.com.br



ÍNDICE	Página
A	
ABAJADORES DE LENGUA	
BRUENINGS	18
ABRE BOCAS	
JENNINGS	18
MC-IVOR	18
MOLT	18
WHITEHEAD	18
AGUJAS	
LUCAE	26/27
OBWEGESER	27
ALICATES	
CORTE LATERAL	27
ANUSCÓPIOS	
BENSAUDE	27
PITANGA	27
B	
BISTURI	
ABRAHAM	28
BRUENINGS	28
ESMARCH	28
C	
CÂNULA	
BALIU	30
FRAZIER	30
CAUTERIO	
WADSWORTH-TOOD	30
CINCELES PARA HUESOS	
LAMBOTTE	42
STILLE	42
CIZALLAS	
LISTON	31
LUER	31
RUSKIN LISTON	32
SEMB	32
STILLE LISTON	32
STILLE LISTON KEY	33
STILLE LUER	33
STILLE P/ GESSO	33
COSTOTOMOS	
COLLIN	33
GLUCK	34
COSTOTOMO MOD. SIMPLES	34
SAUERBRUCH	34

ÍNDICE	Página
CRANEOCLASTRO	
BRAUM	34
CUCHILLOS	
BALLENGER	40
BECKMAN	40
CATLIN	41
COLLIN	41
CURETAS	
BRUNS	34
NOVAK	35
MEYHOEFER	35
RECAMIER	35
SCHROEDER	35
WALLICH	36
WILLIGER	36
CURETA DE BIOPSIA UTERINA	
BALIU	76
D	
DILATADORES	
DESJARDIM	36
LA-BORDE	36
SIMS	37
TROUSSEAU	37
VELA DE HEGAR	37
WYLIE	37
DISECTORES PARA AMIGDALAS	
COLVER	36
HURD	36
E	
ESCOFINAS NASALES	
AUFRICHT	75
COTTLE	75
LEWIS	76
ESPÁTULAS	
FLEXÍVEL	37
REVERDIN	38
TUFFIER	38
ESPÉCULOS	
AURICULAR DE HARTMANN	38
AURICULAR DE POLITZER	38
COLLIN	39
KILLIAN	39
MATHIEU	39
HARTMANN	39
PITANGA SANTOS	40
SIMS	40

ÍNDICE	Página
ESPÉCULO RECTAL	
PITANGA	76
ESTILETES	
BIOLIVAR	40
ESTILETE P/ ALGODÃO	40
F	
FLEBO - EXTRATOR	
FLEBOEXTRATOR	41
FORCEPS	
AUXILIAR P/ PARTO	41
KIELAND	41
LEE	41
PIPER	42
SIMPSON	42
G	
GANCHOS	
BRAUM	43
GILLIES	43
HARTMAN	43
JOSEPH	43
MODENHAUER	43
ZAFAL	43
H	
HISTERÓMETROS	
COLLIN	44
SIMS	44
I	
INSTRUMENTAL DE MEDICIÓN	
IWANSON	38
INSTRUMENTAL PARA BIOPSIA DE PIEL	
KEYS	75
L	
LEGRAS - PERIOSTÓTOMOS	
DOYEN	76
FARABEUF	77
LAMBOTTE	77
M	
MANGOS	
CABO INTERMEDIÁRIO	29
CABO P/ BISTURI	29/30
CABO P/ ESPELHO DE LARINGE	30
CABO P/ SERRA DE GIGLI	30
MARTELOS	
BABINSKI	44
BUCK	44

ÍNDICE	Página
DEJERINE	44
HAJEK	45
MEAD	45
NEUFIELD	45
TEYLOR	45
UNIVERSAL	45
WILLIGER	45
MENISCÓTOMOS	
SMILLIE	46
P	
PELVIMETROS	
COLLIN	46
MARTIN	47
PERFORADOR	
HUDSON	46
SMELLIE	46
PINZAS	
ABADIE	47
ADSON	47
ADSON BROWN	47
ALLIS	47
ANATÔMICA DISSECÇÃO	48
ANATÔMICA DENTE DE RATO	48
ANATÔMICA PONTA FINA	48
ASCH	48
AUTO CENTRANTE	48
AUXILIAR DE SUTURA	48
BABCOCK	49
BACKHAUS	49
BERNHARD	49
BEYER	49
BISHOP	49
BOZEMANN	50
BRUENINGS	50
BULDOG	50
CHERON	50
CHEVALIER	50/51
CITELLI	51
CLAMP	51
CLÍNICA P/ ALGODÃO	51
COLIBRI BARRAQUER	51
COLLIN CORAÇÃO	51
COLLIN P/ CURATIVO	52
COLLIN P/ INSTRUMENTOS	52
COLLIN OVAL	52
COTTLE WALSHAM	52
CRAFOORD	52
CRILE	52
CUSHING	53
DANDY	54
DARTIGUES	54

ÍNDICE Página

PINZAS	
DE - BAKEY	54
DOYEN P/ CAMPO	54
DOYEN - ATRAUMA	54
DOYEN INTESTINAL E COPROSTASI	55
DUCK BILL	55
DUVAL	55
FARABEUF LAMBOTTE	55/56
FARABEUF VAN-BUREN	56
FAURE	56
FERGUSSON	56
FERRIS SMITH KERRISON	56/57
FOERSTER	57
GLOVER	57
GRUENWALD	58
GUYON	58
HALSTEAD MOSQUITO	58
HARTMANN MICRO	59
HARTMANN P/ CURATIVO	59
HARTMANN P/ CORPO ESTRANHO	59/60
HISTOLOGICA	60
JONES	60
KELLY	60
KERRISON	61
KOCHER HEMOSTATICA	61
KOCHER INTESTINAL E COPROSTASI	61
KOCHER - ATRAUMA	61/62
LAMBOTTE	62
LANE	62
LEKSELL	62
LOWMANN	62
LUCAE	63
LUER SIMPLES	63
LUER DUPLA ARTICULAÇÃO	63
MAGIL	63
MARTIN	64
MATHIEU	64
MENKEN OU KOGAN	64
MICHEL	64
MARTEL	64
MIXTER	65
MOYNIHAN	65
MUSEUX	65
NELSON	65
PINÇA P/ BIOPSIA MICRO	65/66
PATA DE GATO	66
PAYR	66
PEAN	66
PELKMANN	67
PENNINGTON	67
PERRY	67
POZZI	67
PROFESSOR MEDINA	67
RANDALL	67
REINOLD	68

ÍNDICE Página

ROCHESTER CARMALT	68
ROCHESTER PEAN	68
ROMPE BOLSA	68
ROWE	69
RUSKIN	69
SATINSKY	69
SCHIMIDT	70
SCHUBERT	70
SCHUMACHER	70
SEMB	70
SNELLEN	70/71
TAKAHASHI	71
THOMAS GAYLOR	71
TROELTSCH	71
YEOMAN	71/72
WERTHEIM-CULLEN	72
WINTER	72

PINZAS PARA ROMPER LOS VENDAJES ENYESADOS

HENNING	19
WOLFF	19

PORTA HOJAS DE AFEITAR

CASTROVIEJO	75
-------------	----

PORTA PINZAS

MAYO	33
------	----

PORTA - AGUJAS

CASTROVIEJO	72/73
CRILE WOOD	73
DERF	73
ERMOLD	73
MATHIEU	73
MAYO HEGAR	74
PORTA AGULHA P/ FIO DE AÇO	74

PORTA - AGUJAS CARBURO DE TUNGSTENO

GILLIES	74
MAYO HEGAR	74
MATHIEU	74
OLSEN HEGAR	74

S

SEPARADORES

ADSON-BABY	19
ALM	19
AUFRICHT	19
BAUFOUR	19/20
BECKMAN ADSON	20
BENNET	20
CASTROVIEJO	20
DESMARRES	20
FARABEUF	20
FINOCHIETTO	21

ÍNDICE	Página
SEPARADORES	
GELPI	21
GOSSET	21
HENLEY	21
HOHMANN	21
ISRAEL	21/22
KOCHER	22
LANGENBECK	23
LOVE	23
MEAD	24
MILLIN	24
OLLIER	24
RICHARDSON	24
SEN-MULLER	24
VOLKMANN	25/26
WEITLANER	26

SEPARADORES OFTALMOLÓGICOS	
BARRAQUER	28
CASTROVIEJO	28
COOK	29
PARK	29

SIERRA	
CHARRIERE	77
GIGLI	77
JOSEPH	78
LANGENBECK	78
MATHIEU	78
WEISS	78
WIGMORE	78

SIERRA NUDO	
BRUENINGS	79

SONDAS	
ITARD	79
TENTACANULA	79

T

TIJERAS	
BALIU	79
BARRAQUER	79
BELLUCCI	79/80
CASTROVIEJO	80
CIRÚRGICA	80/81
ENTERÓTOMO	81
GOLDMAN FOX	81
HEYMANN	82
IRIS OU GENGIVA	82
JOSEPH	82
KILNER	82
LISTER	83
MAYO STILLE	83
METZEMBAUM	83

ÍNDICE	Página
NOYES IRIS	84
OURO	84
POTTS - SMITH	84/85
SCHUMACHER	85
SIMS	85
SMITH	85
SPENCER	85
STEVENS	86
TESOURA P/ CORDÃO UMBILICAL	86
VANNAS	86
WESTCOTT	86/87

TIRABUZÓN PARA FIBROMA	
DOYEN	77

TUBOS DE ASPIRACIÓN	
YANKAUER	28

V

VALVULAS	
AUVARD	87
DOYEN	87
DOYEN SUB-PUBIANA	87
VALVULA P/ AFASTADOR BAUFOR	87



INSTRUMENTOS CIRÚRGICOS

www.abcinstrumentos.com.br





Os produtos exibidos nesse catálogo estão dispostos em ordem alfabética de acordo com seus nomes em português.



Products displayed in this catalog are arranged in alphabetical order according to their names in portuguese.



Los productos que aparecen en este catálogo están dispuestos en orden alfabético de acuerdo con sus nombres en portugués.

ABRIDORES DE BOCA

MOUTH GAGS

ABRE BOCAS



COD. 0978 - JENNINGS 11 cm
 COD. 0979 - JENNINGS 13 cm
 COD. 0980 - JENNINGS 15 cm

ABAIXADORES DE LÍNGUA

TONGUE DEPRESSOR

ABAJADOR DE LENGUA

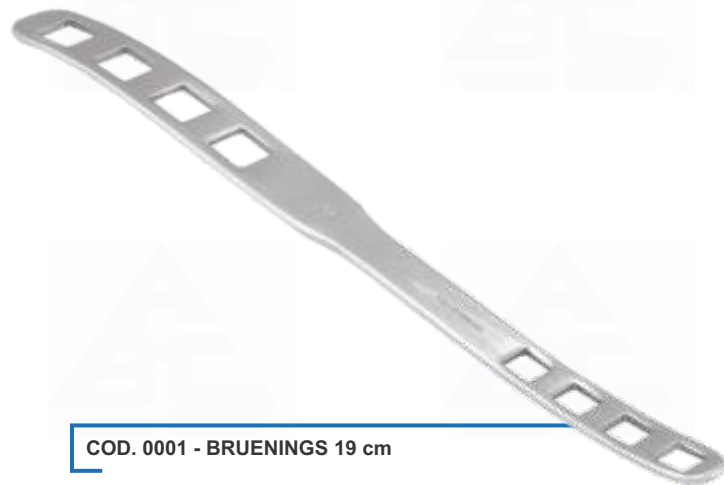

COD. 0001 - BRUENINGS 19 cm



COD. 0597 - MC-IVOR SEM SUCCÃO C/ 3 LAMINAS
 COD. 0921 - MC-IVOR COM SUCCÃO C/ 3 LAMINAS



COD. 0565 - MOLT 10 cm INFANTIL



COD. 0981 - WHITEHEAD 11 cm COM TRAVA
 COD. 0982 - WHITEHEAD 13 cm COM TRAVA
 COD. 0983 - WHITEHEAD 15 cm COM TRAVA

ABRIDORES DE GESSO

PLASTER CAST SPREADER

PINZAS PARA ROMPER LOS VENDAJES ENYESADOS

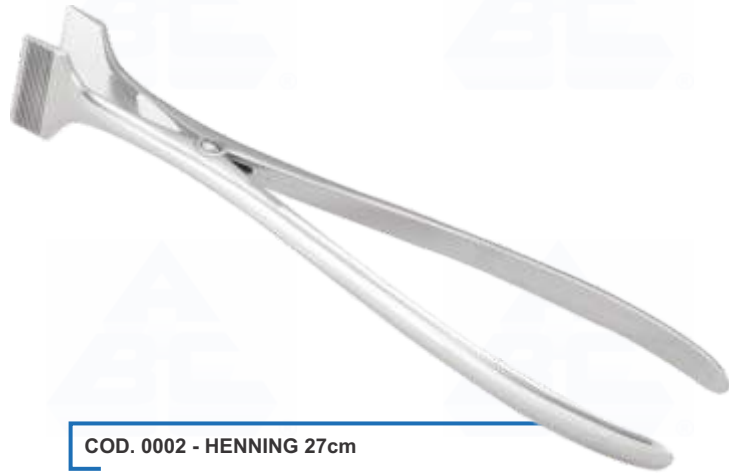

COD. 0002 - HENNING 27cm



COD. 0003 - WOLFF 23cm

AFASTADORES

RETRACTOR

SEPARADORES



COD. 0385 - ADSON-BABY 16 cm
ARTICULADO P/ USO GERAL



COD. 0386 - ALM 4 X 4 AGUDO P/ PLÁSTICA



COD. 0922 - AUFRICHT 16 cm P/ CIRURGIA NASAL



COD. 0004 - BAUFOR ABDOMINAL COM
VÁLVULA CURVA 45 X 80
COD. 0561 - BAUFOR ABDOMINAL COM
VÁLVULA CURVA 20 X 25

AFASTADORES

RETRACTOR

SEPARADORES



COD. 0988 - BAUFOR ABDOMINAL COM VÁLVULA RETA 70 X 100



COD. 0005 - BECKMAN ADSON 4 X 4 31 cm P/ USO GERAL



COD. 0936 - BENNET 24 cm P/ CIRURGIA ÓSSEA



COD. 0650 - CASTROVIEJO 8 cm P/ MICRO CIRURGIA



**COD. 0517 - DESMARRES Nº1 12 mm P/ USO GERAL
 COD. 0518 - DESMARRES Nº2 14 mm P/ USO GERAL
 COD. 0519 - DESMARRES Nº3 16 mm P/ USO GERAL
 COD. 0520 - DESMARRES Nº4 18 mm P/ USO GERAL**



**COD. 0006 - FARABEUF BABY (7 X 100 mm) P/ USO GERAL
 COD. 0007 - FARABEUF INFANTIL (10 X 120 mm) P/ USO GERAL
 COD. 0008 - FARABEUF ADULTO (13 X 125 mm) P/ USO GERAL
 COD. 0498 - FARABEUF EXTRA (15 X 150 mm) P/ USO GERAL
 COD. 0499 - FARABEUF EXTRA GRANDE (20 X 180 mm) P/ USO GERAL**

AFASTADORES

RETRACTOR

SEPARADORES

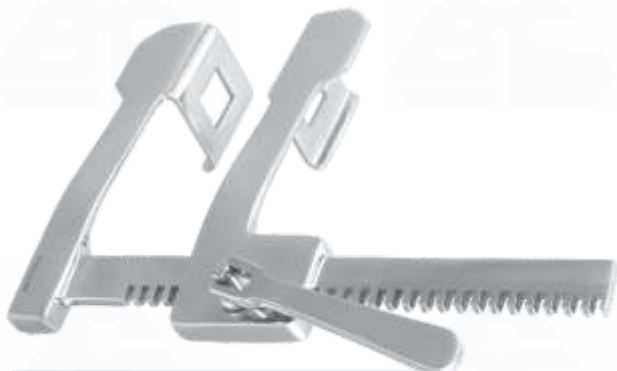

COD. 0562 - FINOCHIETTO BABY 18 X 22 - 8 cm P/ TORAX
 COD. 0563 - FINOCHIETTO 25 X 40 - 13 cm P/ TORAX
 COD. 0009 - FINOCHIETTO 38 X 45 - 16 cm P/ TORAX
 COD. 0010 - FINOCHIETTO 40 X 65 - 18 cm P/ TORAX

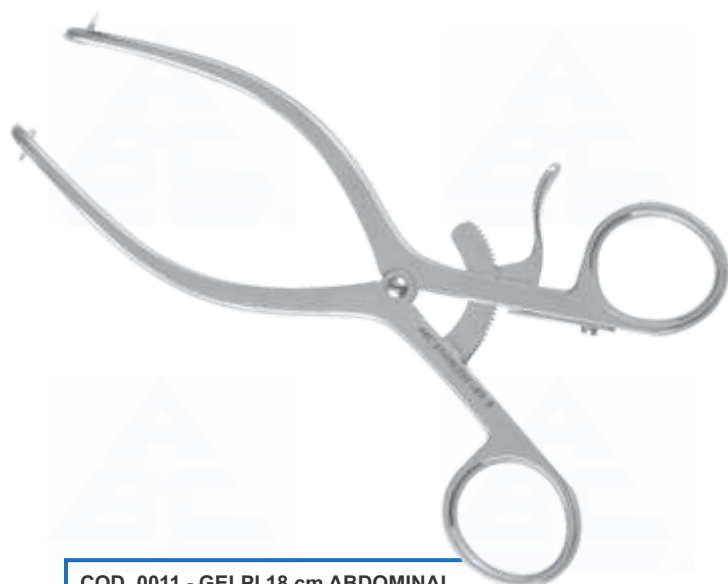

COD. 0011 - GELPI 18 cm ABDOMINAL



COD. 0364 - GOSSET 12 cm ABDOMINAL C/ DUPLO BARRAMENTO
 COD. 0012 - GOSSET 16 cm ABDOMINAL C/ DUPLO BARRAMENTO
 COD. 0013 - GOSSET 24 cm ABDOMINAL C/ DUPLO BARRAMENTO
 COD. 0014 - GOSSET 30 cm ABDOMINAL C/ DUPLO BARRAMENTO



COD. 1138 - HENLEY 16,5 - 3 X 4
 COM VÁLVULA 16 X 19 cm



COD. 0932 - HOHMANN 8 mm PONTA FINA P/ CIRURGIA ÓSSEA
 COD. 0933 - HOHMANN 18 mm PONTA FINA P/ CIRURGIA ÓSSEA
 COD. 0934 - HOHMANN 43 mm PONTA FINA P/ CIRURGIA ÓSSEA
 COD. 0935 - HOHMANN 70 mm PONTA FINA P/ CIRURGIA ÓSSEA



COD. 0479 - ISRAEL COM 4 DENTES
 23 cm P/ USO GERAL

AFASTADORES

RETRACTOR

SEPARADORES



COD. 0480 - ISRAEL COM 5 DENTES
23 cm P/ USO GERAL



COD. 0481 - ISRAEL COM 6 DENTES
23 cm P/ USO GERAL



COD. 0482 - KOCHER COM 2 DENTES
ROMBO 22 cm P/ USO GERAL



COD. 0483 - KOCHER COM 3 DENTES ROMBO
22 cm P/ USO GERAL



COD. 0484 - KOCHER COM 4 DENTES ROMBO
22 cm P/ USO GERAL



COD. 0485 - KOCHER COM 6 DENTES ROMBO
22 cm P/ USO GERAL

AFASTADORES

RETRACTOR

SEPARADORES

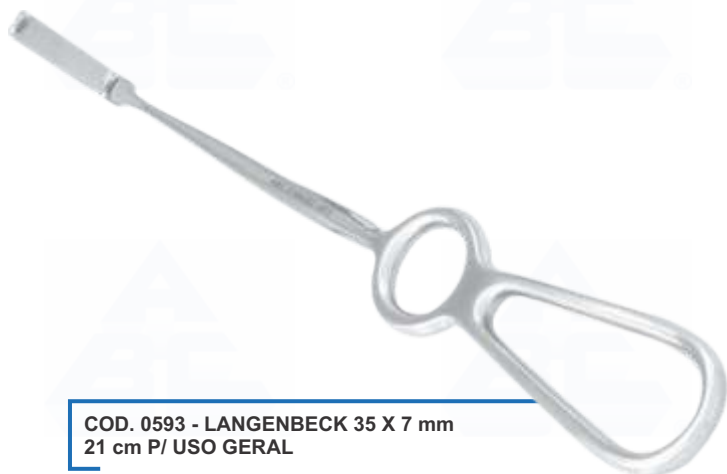

COD. 0593 - LANGENBECK 35 X 7 mm
21 cm P/ USO GERAL



COD. 0594 - LANGENBECK 35 X 10 mm
21 cm P/ USO GERAL



COD. 0595 - LANGENBECK 35 X 15 mm
21 cm P/ USO GERAL



COD. 0558 - LOVE RETO P/ CIRURGIA GERAL



COD. 0559 - LOVE 45° ANGULADO P/ CIRURGIA GERAL



COD. 0560 - LOVE 60° ACOTOVELADO P/ CIRURGIA GERAL

AFASTADORES

RETRACTOR

SEPARADORES

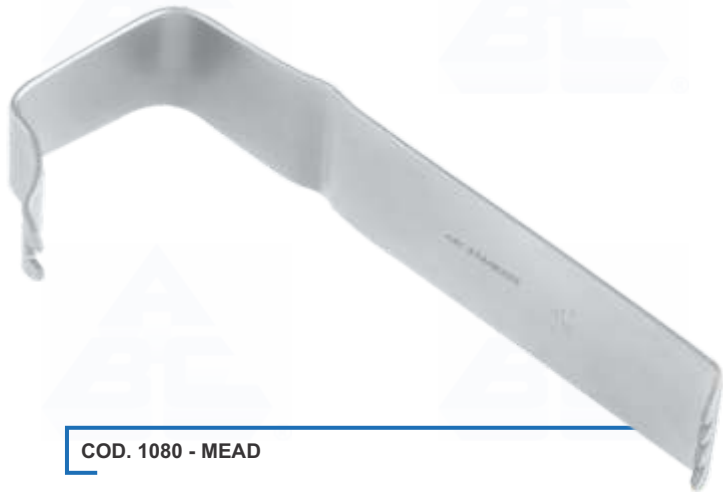

COD. 1080 - MEAD



COD. 0995 - MILLIN C/ 5 LAMINAS ABDOMINAL E VESICAL



COD. 0486 - OLLIER COM 2 DENTES
22,5 cm P/ USO GERAL



COD. 0487 - OLLIER COM 4 DENTES
22,5 cm P/ USO GERAL



COD. 0015 - RICHARDSON 25 cm 24 X 20
P/ CIRURGIA GERAL
COD. 0016 - RICHARDSON 25 cm 33 X 29
P/ CIRURGIA GERAL
COD. 0017 - RICHARDSON 25 cm 40 X 38
P/ CIRURGIA GERAL
COD. 0018 - RICHARDSON 25 cm 50 X 22
P/ CIRURGIA GERAL



COD. 0019 - SEN-MULLER DUPLO 17 cm P/ USO GERAL

AFASTADORES

RETRACTOR

SEPARADORES



COD. 0488 - VOLKMANN COM 2 DENTES ROMBO
22 cm P/ USO GERAL



COD. 0489 - VOLKMANN COM 3 DENTES ROMBO
22 cm P/ USO GERAL



COD. 0490 - VOLKMANN COM 4 DENTES ROMBO
22 cm P/ USO GERAL



COD. 0491 - VOLKMANN COM 6 DENTES ROMBO
22 cm P/ USO GERAL



COD. 0492 - VOLKMANN COM 8 DENTES ROMBO
22 cm P/ USO GERAL



COD. 0493 - VOLKMANN COM 2 DENTES FINO
22 cm P/ USO GERAL

AFASTADORES

RETRACTOR

SEPARADORES



COD. 0494 - VOLKMANN COM 3 DENTES
FINO 22 cm P/ USO GERAL



COD. 0495 - VOLKMANN COM 4 DENTES
FINO 22 cm P/ USO GERAL



COD. 0496 - VOLKMANN COM 6 DENTES
FINO 22 cm P/ USO GERAL



COD. 0497 - VOLKMANN COM 8 DENTES
FINO 22 cm P/ USO GERAL



COD. 1140 - WEITLANER 2 X 3 DENTES 10,5 cm P/ USO GERAL
COD. 0020 - WEITLANER 2 X 3 DENTES 14 cm P/ USO GERAL
COD. 0021 - WEITLANER 3 X 4 DENTES 18 cm P/ USO GERAL
COD. 0022 - WEITLANER 3 X 4 DENTES 20 cm P/ USO GERAL

AGULHAS

NEEDLES

AGUJAS

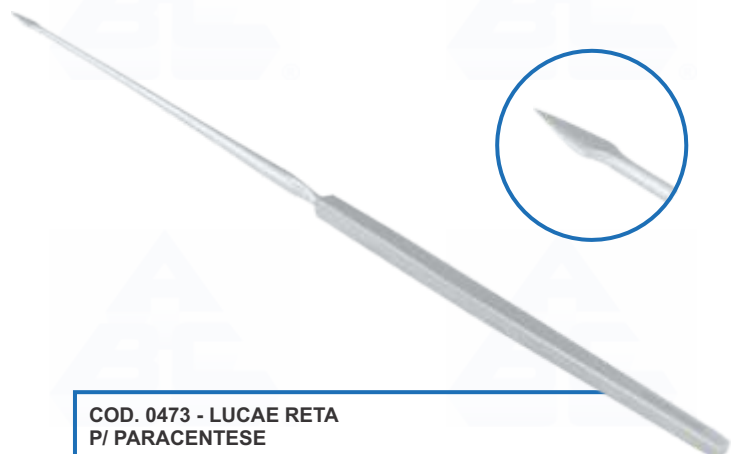

COD. 0473 - LUCAE RETA
P/ PARACENTESE

AGULHAS

NEEDLES

AGUJAS

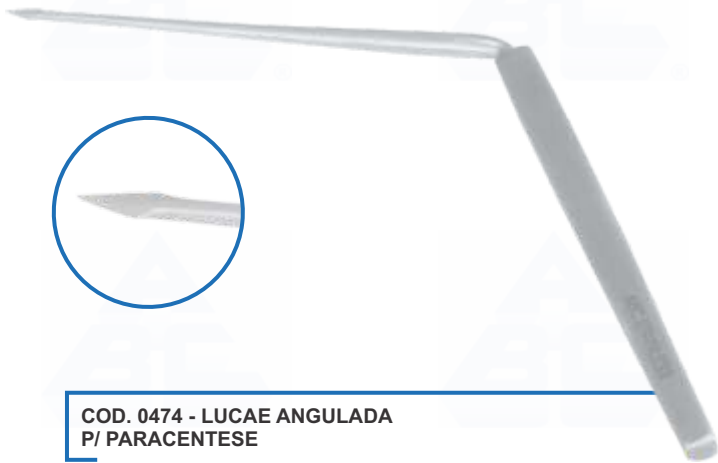

COD. 0474 - LUCAE ANGULADA
P/ PARACENTESE



COD. 0475 - LUCAE BAIONETA
P/ PARACENTESE

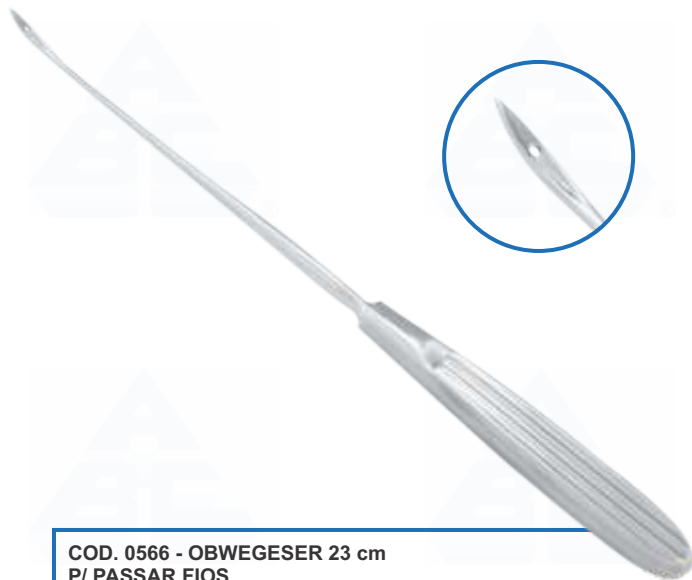

COD. 0566 - OBWEGESER 23 cm
P/ PASSAR FIOS

ALICATES

PLIERS

ALICATES



COD. 0023 - CORTE LATERAL EM
AÇO INOX P/ OSSO

ANUSCÓPIOS

ANOSCOPES

ANOSCOPIOS

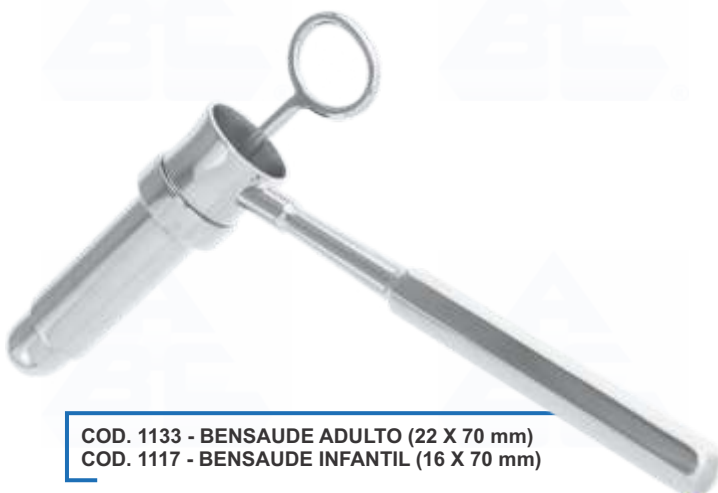

COD. 1133 - BENSUADE ADULTO (22 X 70 mm)
COD. 1117 - BENSUADE INFANTIL (16 X 70 mm)



COD. 1052 - PITANGA N°1 (19 X 85 mm)
COD. 1053 - PITANGA N°2 (22 X 85 mm)
COD. 1054 - PITANGA N°3 (25 X 85 mm)

ASPIRADORES

SUCTION TUBES

TUBOS DE ASPIRACIÓN



COD. 1002 - YANKAUER COM 24 cm PARA SUCÇÃO
COD. 0024 - YANKAUER COM 27 cm PARA SUCÇÃO

BISTURIS

SCALPELS

BISTURÍS

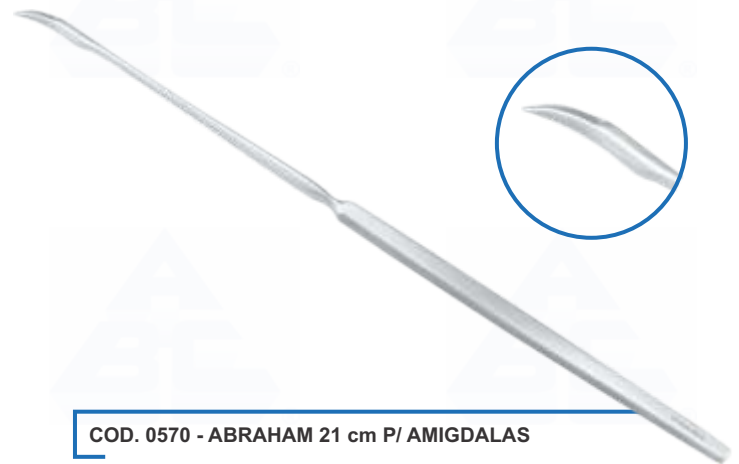

COD. 0570 - ABRAHAM 21 cm P/ AMIGDALAS



COD. 0571 - BRUENINGS 23 cm P/ AMIGDALAS



COD. 0906 - ESMARCH 18 cm P/ GESSO

BLEFAROSTATOS

EYES SPECULUM

SEPARADORES OFTALMOLÓGICOS



COD. 0972 - BARRAQUER (COLIBRI) 3 cm P/ OFTALMOLOGIA
COD. 0973 - BARRAQUER (COLIBRI) 4 cm P/ OFTALMOLOGIA



COD. 0650 - CASTROVIEJO 8 cm
P/ MICRO CIRURGIA

BLEFAROSTATOS

EYES SPECULUM

SEPARADORES OFTALMOLÓGICOS



COD. 0975 - COOK 4 cm P/ OFTALMOLOGIA
 COD. 0976 - COOK 5 cm P/ OFTALMOLOGIA



COD. 0974 - PARK 8 cm P/ OFTALMOLOGIA

CABOS

HANDLES

MANGOS



COD. 1102 - CABO INTERMEDIÁRIO
 C/ REGULAGEM 6 cm P/ OTORRINO



COD. 0025 - CABO P/ BISTURI Nº 3 INOX
 13 cm P/ LAMINAS Nº 10 A 17



COD. 0026 - CABO P/ BISTURI Nº 4 INOX
 14 cm P/ LAMINAS Nº 18 A 36



COD. 0027 - CABO P/ BISTURI Nº 7 INOX
 17 cm P/ LAMINAS Nº 10 A 17

CABOS

HANDLES

MANGOS

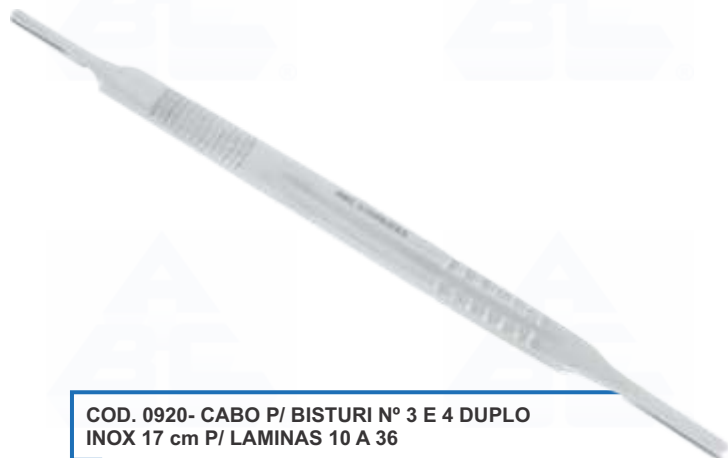

**COD. 0920 - CABO P/ BISTURI Nº 3 E 4 DUPLO
INOX 17 cm P/ LAMINAS 10 A 36**



**COD. 1101 - CABO P/ ESPELHO DE LARINGE
C/ REGULAGEM 10,5 cm**



COD. 0640 - CABO P/ SERRA DE GIGLI

CÂNULAS

CANNULA

CÂNULAS



COD. 0034 - BALIU 17 cm P/ ASPIRAÇÃO UTERINA



**COD. 0028 - FRAZIER COM MANDRIL P/ SUCÇÃO 3 mm
COD. 1118 - FRAZIER COM MANDRIL P/ SUCÇÃO 4 mm
COD. 1119 - FRAZIER COM MANDRIL P/ SUCÇÃO 5 mm**

CAUTÉRIO

CAUTER

CAUTERIO



**COD. 0445 - WADSWORTH-TODD
BICO DE PASSARINHO 15 cm**

CIZALHAS

BONE CUTTING FORCEPS

CIZALLAS

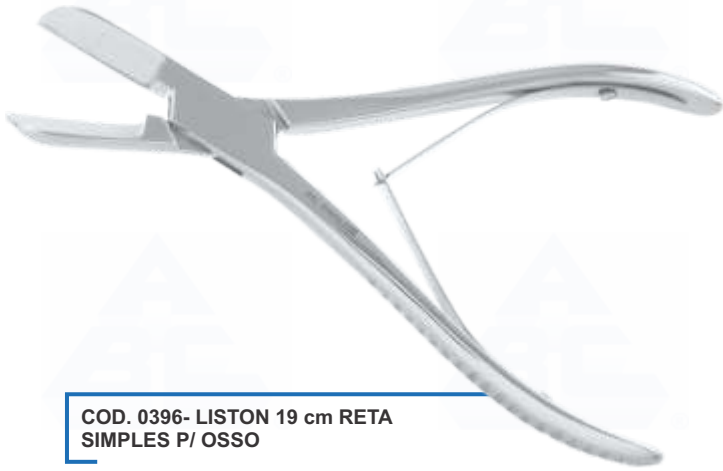

COD. 0396- LISTON 19 cm RETA
SIMPLES P/ OSSO



COD. 0397 - LISTON 19 cm CURVA
SIMPLES P/ OSSO



COD. 0633- LUER GOIVA CURVA
16 cm P/ OSSO (ALVEOLÓTOMO)



COD. 0634- LUER GOIVA RETA
16 cm P/ OSSO (ALVEOLÓTOMO)



COD. 0591- LUER GOIVA RETA
17 cm SIMPLES P/ OSSO



COD. 0592- LUER GOIVA CURVA
17 cm SIMPLES P/ OSSO

CIZALHAS

BONE CUTTING FORCEPS

CIZALLAS

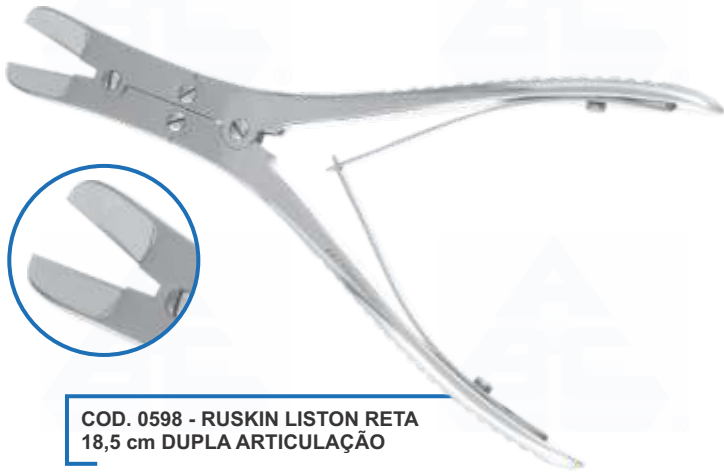

COD. 0598 - RUSKIN LISTON RETA
18,5 cm DUPLA ARTICULAÇÃO

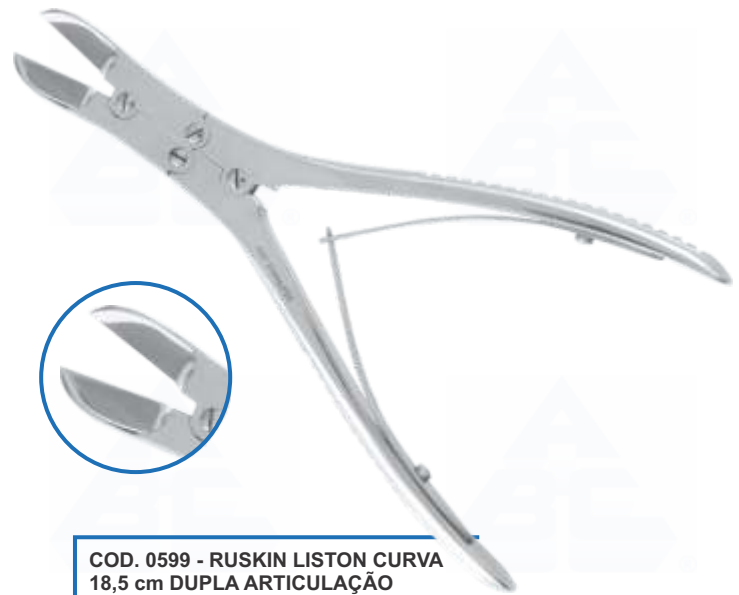

COD. 0599 - RUSKIN LISTON CURVA
18,5 cm DUPLA ARTICULAÇÃO



COD. 0600 - SEMB RETA 23 cm DUPLA ARTICULAÇÃO
COD. 0602 - SEMB RETA 27 cm DUPLA ARTICULAÇÃO



COD. 0601 - SEMB CURVA 23 cm DUPLA ARTICULAÇÃO
COD. 0603 - SEMB CURVA 27 cm DUPLA ARTICULAÇÃO

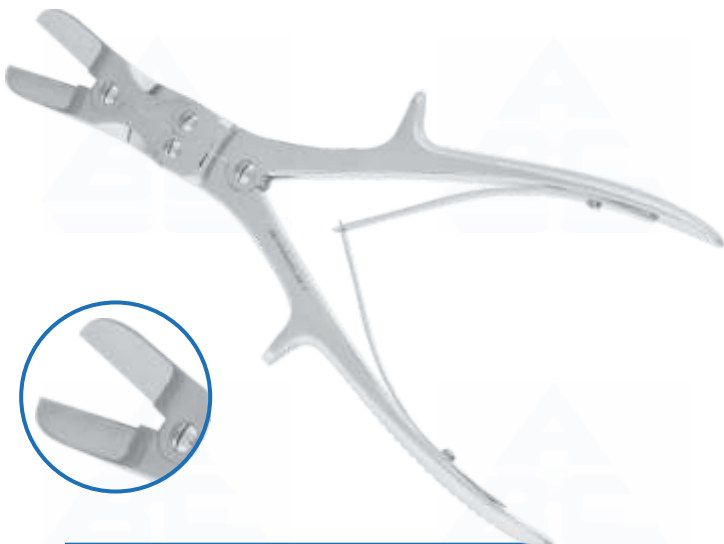

COD. 0608 - STILLE LISTON RETA 23 cm DUPLA ARTICULAÇÃO
COD. 0029 - STILLE LISTON RETA 27 cm DUPLA ARTICULAÇÃO



COD. 0609 - STILLE LISTON CURVA 23 cm DUPLA ARTICULAÇÃO
COD. 0030 - STILLE LISTON CURVA 27 cm DUPLA ARTICULAÇÃO

CIZALHAS

BONE CUTTING FORCEPS

CIZALLAS

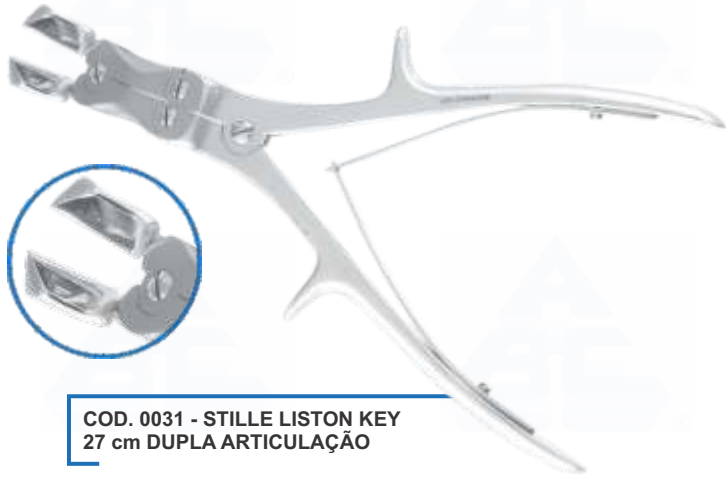

COD. 0031 - STILLE LISTON KEY
27 cm DUPLA ARTICULAÇÃO

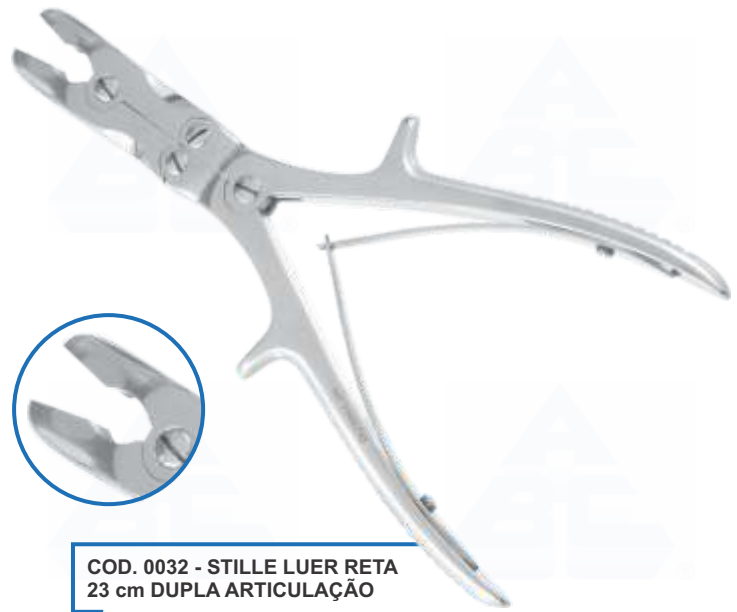

COD. 0032 - STILLE LUER RETA
23 cm DUPLA ARTICULAÇÃO



COD. 0033 - STILLE LUER CURVA
23 cm DUPLA ARTICULAÇÃO



COD. 0398 - STILLE P/ GESSO 26 cm
COD. 0399 - STILLE P/ GESSO 37 cm

CLIPS

FORCEPS HOLDER

PORTA PINZAS



COD. 0863 - MAYO 14 cm (PORTA - INSTRUMENTOS)

COSTOTOMOS

RIB SHEARS

COSTOTOMOS



COD. 0068 - COLLIN 19 cm
P/ CIRURGIA TÓRAX E PULMÃO

COSTOTOMOS

RIB SHEARS

COSTOTOMOS



COD. 0039 - GLUCK 19 cm
P/ CIRURGIA TÓRAX E PULMÃO
COD. 0040 - GLUCK 22 cm
P/ CIRURGIA TÓRAX E PULMÃO



COD. 0069 - MODELO SIMPLES
22 cm C/ MOLA P/ CIRURGIA TÓRAX E PULMÃO



COD. 0663 - SAUERBRUCH 26 cm
P/ CIRURGIA TÓRAX E PULMÃO

CRANEOCLASTO

CRAINOCLAST

CRANEOCLASTRO

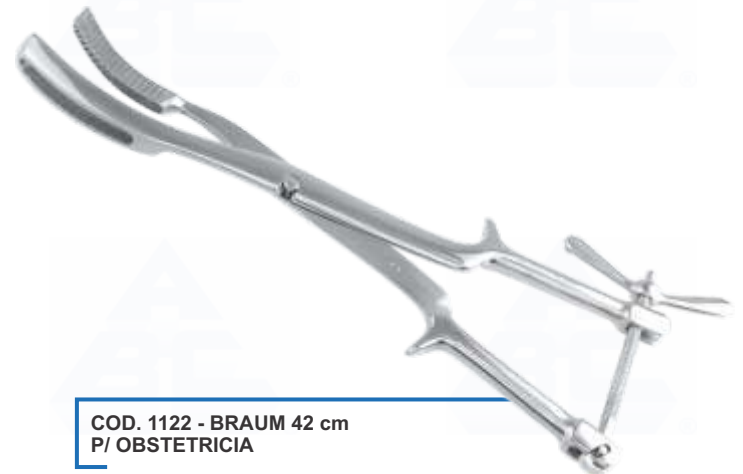

COD. 1122 - BRAUM 42 cm
P/ OBSTETRICIA

CURETAS

CURETTES

CURETAS

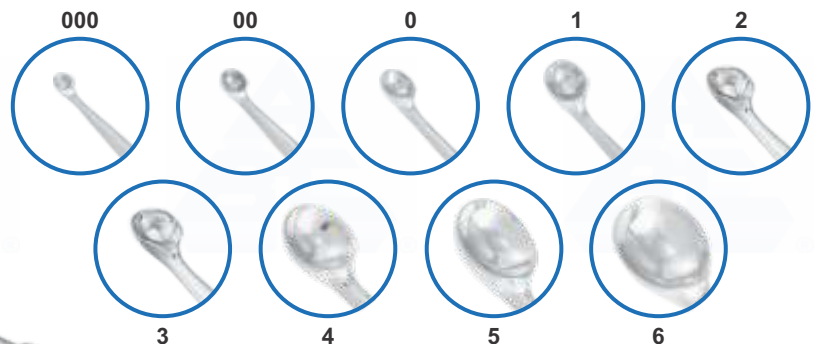

COD. 0917 - BRUNS Nº 000 P/ CIRURGIA ÓSSEA 17 cm
COD. 0918 - BRUNS Nº 00 P/ CIRURGIA ÓSSEA 17 cm
COD. 0919 - BRUNS Nº 0 P/ CIRURGIA ÓSSEA 17 cm
COD. 0041 - BRUNS Nº 1 P/ CIRURGIA ÓSSEA 17 cm
COD. 0042 - BRUNS Nº 2 P/ CIRURGIA ÓSSEA 17 cm
COD. 0043 - BRUNS Nº 3 P/ CIRURGIA ÓSSEA 17 cm
COD. 0044 - BRUNS Nº 4 P/ CIRURGIA ÓSSEA 17 cm
COD. 0045 - BRUNS Nº 5 P/ CIRURGIA ÓSSEA 17 cm
COD. 0046 - BRUNS Nº 6 P/ CIRURGIA ÓSSEA 17 cm



CURETAS

CURETTES

CURETAS

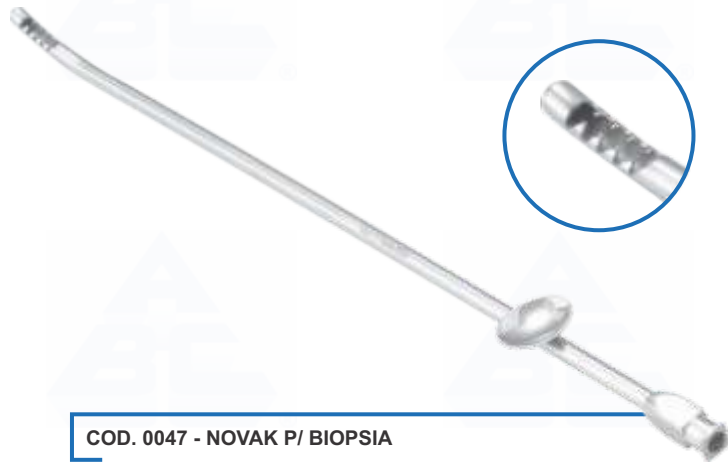

COD. 0047 - NOVAK P/ BIOPSIA

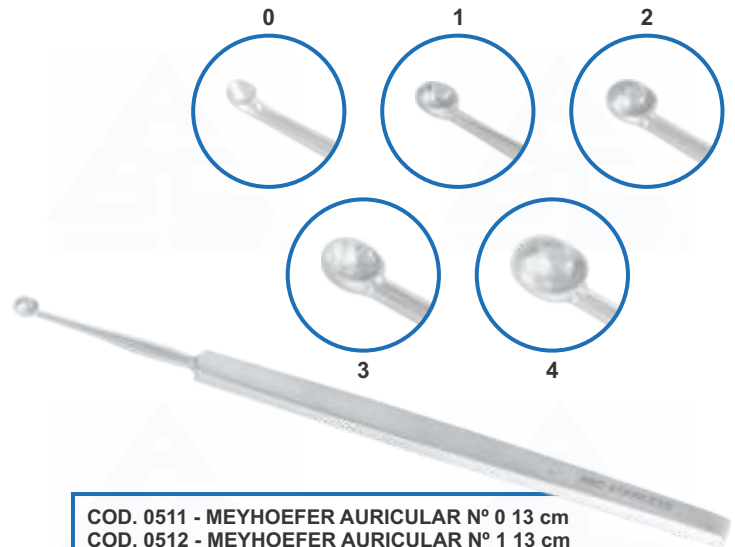

COD. 0511 - MEYHOEFER AURICULAR Nº 0 13 cm
 COD. 0512 - MEYHOEFER AURICULAR Nº 1 13 cm
 COD. 0513 - MEYHOEFER AURICULAR Nº 2 13 cm
 COD. 0514 - MEYHOEFER AURICULAR Nº 3 13 cm
 COD. 0515 - MEYHOEFER AURICULAR Nº 4 13 cm

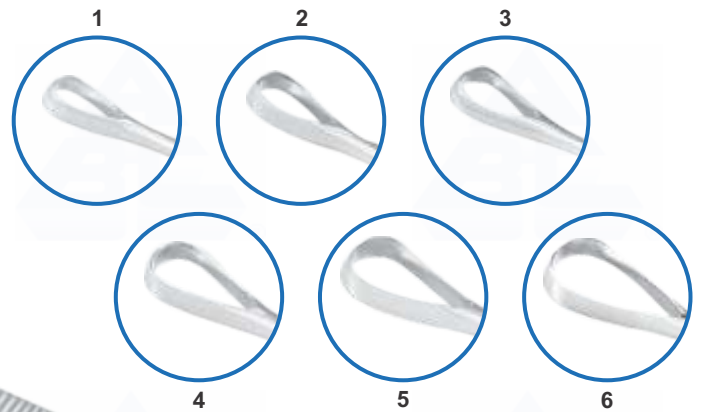

COD. 0048 - RECAMIER GINECOLÓGICA Nº1 - 31 cm
 COD. 0049 - RECAMIER GINECOLÓGICA Nº2 - 31 cm
 COD. 0050 - RECAMIER GINECOLÓGICA Nº3 - 31 cm
 COD. 0051 - RECAMIER GINECOLÓGICA Nº4 - 31 cm
 COD. 0052 - RECAMIER GINECOLÓGICA Nº5 - 31 cm
 COD. 0053 - RECAMIER GINECOLÓGICA Nº6 - 31 cm

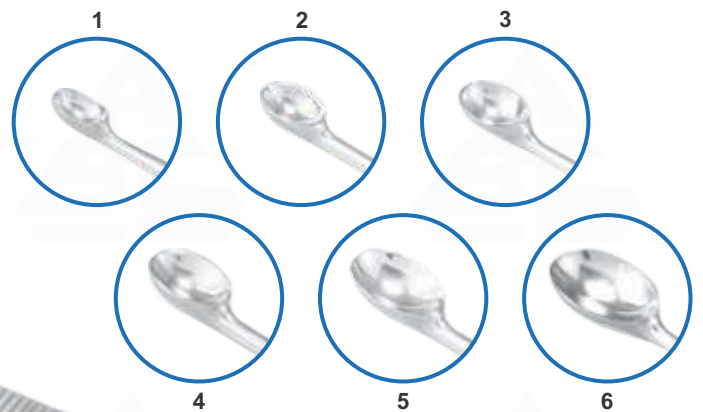

COD. 0054 - SCHROEDER GINECOLÓGICA Nº1 - 30 cm
 COD. 0055 - SCHROEDER GINECOLÓGICA Nº2 - 30 cm
 COD. 0056 - SCHROEDER GINECOLÓGICA Nº3 - 30 cm
 COD. 0057 - SCHROEDER GINECOLÓGICA Nº4 - 30 cm
 COD. 0058 - SCHROEDER GINECOLÓGICA Nº5 - 30 cm
 COD. 0059 - SCHROEDER GINECOLÓGICA Nº6 - 30 cm

CURETAS

CURETTES

CURETAS

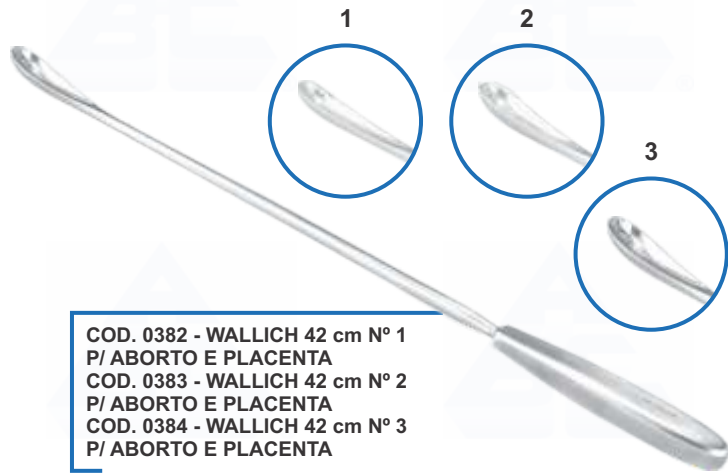

COD. 0382 - WALLICH 42 cm Nº 1
P/ ABORTO E PLACENTA
COD. 0383 - WALLICH 42 cm Nº 2
P/ ABORTO E PLACENTA
COD. 0384 - WALLICH 42 cm Nº 3
P/ ABORTO E PLACENTA



DESCOLADORES

TONSIL DISSECTORS

DISECTORES PARA AMIGDALAS



DILATADORES

DILATORS

DILATADORES

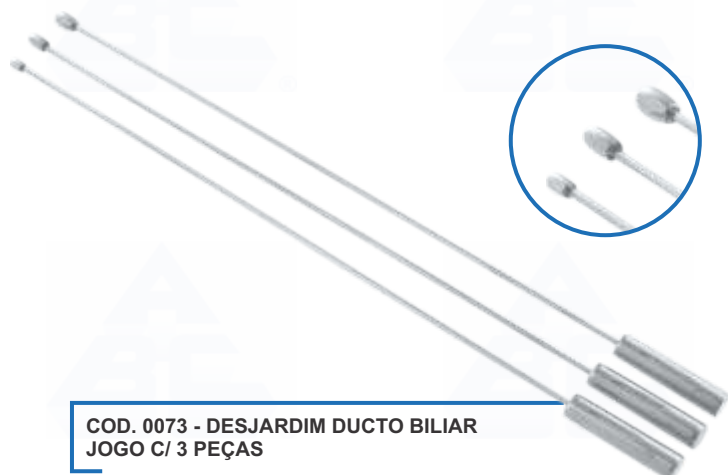

DILATADORES

DILATORS

DILATADORES



COD. 0406 - SIMS C/ 3 RAMOS UTERINO 27 cm



COD. 0075 - TROUSSEAU C/ 2 RAMOS TRAQUEAL 15 cm



- COD. 0076 - VELA DE HEGAR UTERINO Nº 1
- COD. 0077 - VELA DE HEGAR UTERINO Nº 2
- COD. 0078 - VELA DE HEGAR UTERINO Nº 3
- COD. 0079 - VELA DE HEGAR UTERINO Nº 4
- COD. 0080 - VELA DE HEGAR UTERINO Nº 5
- COD. 0081 - VELA DE HEGAR UTERINO Nº 6
- COD. 0082 - VELA DE HEGAR UTERINO Nº 7
- COD. 0083 - VELA DE HEGAR UTERINO Nº 8
- COD. 0084 - VELA DE HEGAR UTERINO Nº 9
- COD. 0085 - VELA DE HEGAR UTERINO Nº 10
- COD. 0086 - VELA DE HEGAR UTERINO Nº 11
- COD. 0087 - VELA DE HEGAR UTERINO Nº 12
- COD. 0088 - VELA DE HEGAR UTERINO Nº 13
- COD. 0089 - VELA DE HEGAR UTERINO Nº 14
- COD. 0090 - VELA DE HEGAR UTERINO Nº 15
- COD. 0091 - VELA DE HEGAR UTERINO Nº 16
- COD. 0092 - VELA DE HEGAR UTERINO Nº 17
- COD. 0093 - VELA DE HEGAR UTERINO Nº 18
- COD. 0094 - VELA DE HEGAR UTERINO Nº 19
- COD. 0095 - VELA DE HEGAR UTERINO Nº 20
- COD. 0096 - VELA DE HEGAR UTERINO Nº 21
- COD. 0097 - VELA DE HEGAR UTERINO Nº 22
- COD. 0098 - VELA DE HEGAR UTERINO Nº 23
- COD. 0374 - VELA DE HEGAR UTERINO Nº 24
- COD. 0375 - VELA DE HEGAR UTERINO Nº 25



COD. 0405 - WYLIE C/ 2 RAMOS UTERINO 31 cm

ESPÁTULAS

SPATULAS

ESPÁTULAS

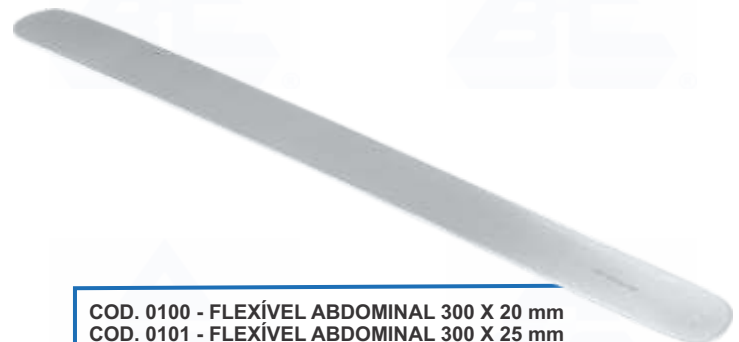

- COD. 0100 - FLEXÍVEL ABDOMINAL 300 X 20 mm
- COD. 0101 - FLEXÍVEL ABDOMINAL 300 X 25 mm
- COD. 0102 - FLEXÍVEL ABDOMINAL 300 X 30 mm
- COD. 0103 - FLEXÍVEL ABDOMINAL 300 X 35 mm
- COD. 0104 - FLEXÍVEL ABDOMINAL 300 X 40 mm
- COD. 0105 - FLEXÍVEL ABDOMINAL 300 X 45 mm
- COD. 0106 - FLEXÍVEL ABDOMINAL 300 X 50 mm

ESPÁTULAS

SPATULAS

ESPÁTULAS



COD. 0108 - REVERDIN ABDOMINAL
BAIONETA



COD. 0107 - REVERDIN ABDOMINAL
RETA



COD. 0109 - TUFFIER ABDOMINAL 200 X 18 X 24 mm

ESPECÍMETROS

MEASURING INSTRUMENTS

INSTRUMENTAL DE MEDICIÓN

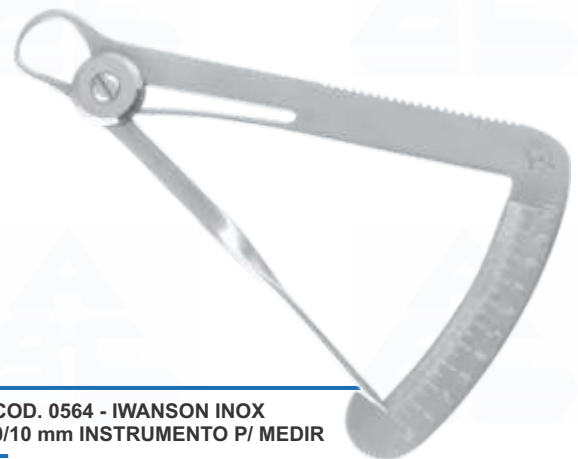

COD. 0564 - IWANSON INOX
0/10 mm INSTRUMENTO P/ MEDIR

ESPÉCULOS

SPECULUM

ESPÉCULOS



COD. 1134 - AURICULAR HARTMANN
3mm - 4,5mm - 5,5mm - 6,5mm



COD. 1134 - AURICULAR HARTMANN
3mm - 4,5mm - 5,5mm - 6,5mm

ESPÉCULOS

SPECULUM

ESPÉCULOS



COD. 0110 - COLLIN VAGINAL
P/ VIRGEM



COD. 0111 - COLLIN VAGINAL Nº 1 PEQUENO
COD. 0112 - COLLIN VAGINAL Nº 2 MÉDIO
COD. 0113 - COLLIN VAGINAL Nº 3 GRANDE



COD. 0366 - KILLIAN NASAL Nº1 DE 35 mm
COD. 0367 - KILLIAN NASAL Nº2 DE 50 mm
COD. 0368 - KILLIAN NASAL Nº3 DE 75 mm
COD. 0369 - KILLIAN NASAL Nº4 DE 90 mm



COD. 0371 - MATHIEU RETAL
TRIVALVE



COD. 0114 - NASAL HARTMANN Nº1 ADULTO
COD. 0115 - NASAL HARTMANN Nº2 ADULTO
COD. 0116 - NASAL HARTMANN Nº3 ADULTO



COD. 0060 - NASAL HARTMANN Nº1 INFANTIL
COD. 0061 - NASAL HARTMANN Nº2 INFANTIL

ESPÉCULOS

SPECULUM

ESPÉCULOS



**COD. 0994 - PITANGA SANTOS
RETAL 13 cm**



COD. 0370 - SIMS RETAL

ESTILETES

STYLET

ESTILETES

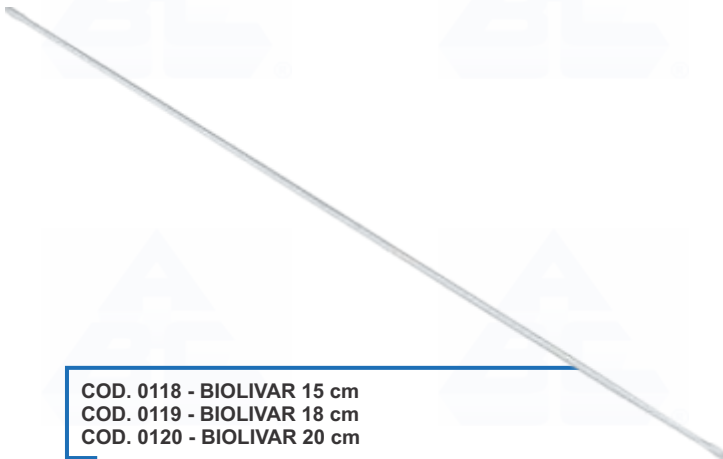

**COD. 0118 - BIOLIVAR 15 cm
COD. 0119 - BIOLIVAR 18 cm
COD. 0120 - BIOLIVAR 20 cm**

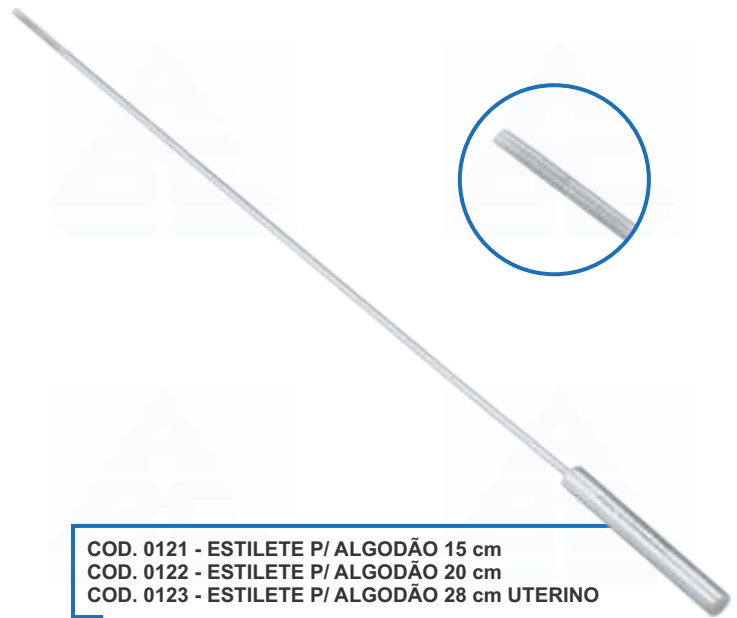

**COD. 0121 - ESTILETE P/ ALGODÃO 15 cm
COD. 0122 - ESTILETE P/ ALGODÃO 20 cm
COD. 0123 - ESTILETE P/ ALGODÃO 28 cm UTERINO**

FACAS

KNIVES

CUCHILLOS



**COD. 0124 - BALLENGER P/ SEPTO BAIONETA Nº1 20 cm
COD. 0125 - BALLENGER P/ SEPTO BAIONETA Nº2 20 cm**



**COD. 0126 - BECKMAN P/ ADENOIDE Nº 1 22 cm
COD. 0127 - BECKMAN P/ ADENOIDE Nº 2 22 cm
COD. 0128 - BECKMAN P/ ADENOIDE Nº 3 22 cm
COD. 0129 - BECKMAN P/ ADENOIDE Nº 4 22 cm
COD. 0130 - BECKMAN P/ ADENOIDE Nº 5 22 cm
COD. 0131 - BECKMAN P/ ADENOIDE Nº 6 22 cm**

FACAS

KNIVES

CUCHILLOS



COD. 0407 - CATLIN LAMINA 13 cm P/ AMPUTAÇÃO
 COD. 0408 - CATLIN LAMINA 16 cm P/ AMPUTAÇÃO
 COD. 0409 - CATLIN LAMINA 19 cm P/ AMPUTAÇÃO
 COD. 0410 - CATLIN LAMINA 22 cm P/ AMPUTAÇÃO



COD. 0411 - COLLIN LAMINA 12 cm P/ AMPUTAÇÃO
 COD. 0412 - COLLIN LAMINA 15 cm P/ AMPUTAÇÃO
 COD. 0413 - COLLIN LAMINA 18 cm P/ AMPUTAÇÃO
 COD. 0414 - COLLIN LAMINA 23 cm P/ AMPUTAÇÃO

FLEBOEXTRATOR

VEIN PROBE SET

FLEBO-EXTRACTOR

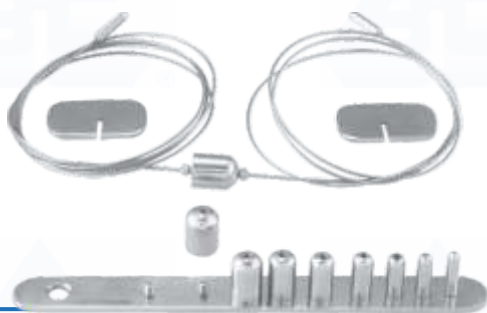

COD. 0639 - FLEBOEXTRATOR CONJUNTO C/ 9 OLIVAS
 DE 4 A 12 mm
 1 VARETA EM CABO DE AÇO INOX ESPESSURA DE 1 mm
 E COMPRIMENTO DE 1 m
 1 VARETA EM CABO DE AÇO INOX ESPESSURA DE 1 mm
 E COMPRIMENTO DE 80 cm

FÓRCEPS

OBSTETRICAL FORCEPS

FORCEPS



COD. 0993 - AUXILIAR P/ PARTO 36 cm



COD. 0134 - KIELAND P/ OBSTETRICIA 39 cm



COD. 0133 - LEE P/ OBSTETRICIA 37 cm

FÓRCEPS

OBSTETRICAL FORCEPS

FORCEPS



COD. 0135 - PIPER P/ OBSTETRICIA 44 cm



COD. 0136 - SIMPSON P/ OBSTETRICIA 30 cm
COD. 0137 - SIMPSON P/ OBSTETRICIA 35 cm

FORMÃO

BONE CHISELS

CINCELES PARA HUESOS



COD. 0911 - LAMBOTTE 25 mm RETO P/ CIRURGIA ÓSSEA
COD. 0913 - LAMBOTTE 30 mm RETO P/ CIRURGIA ÓSSEA
COD. 0915 - LAMBOTTE 38 mm RETO P/ CIRURGIA ÓSSEA

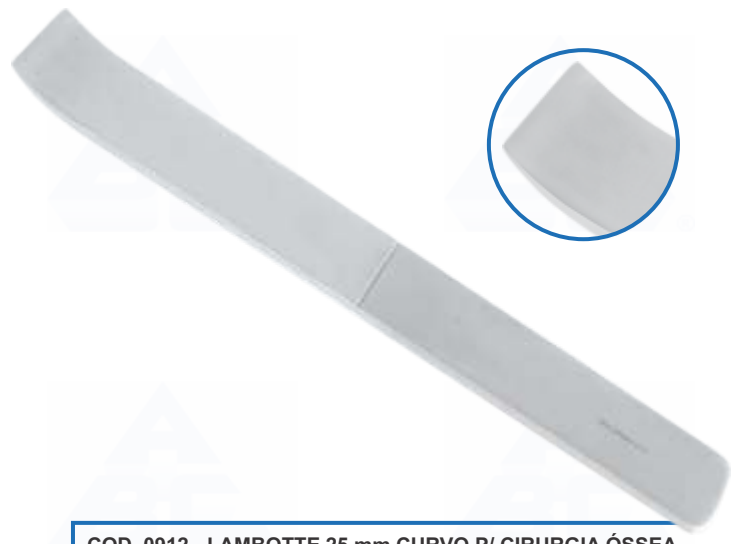

COD. 0912 - LAMBOTTE 25 mm CURVO P/ CIRURGIA ÓSSEA
COD. 0914 - LAMBOTTE 30 mm CURVO P/ CIRURGIA ÓSSEA
COD. 0916 - LAMBOTTE 38 mm CURVO P/ CIRURGIA ÓSSEA



COD. 0138 - STILLE DUPLO BIZEL 8 mm P/ CIRURGIA ÓSSEA
COD. 0139 - STILLE DUPLO BIZEL 10 mm P/ CIRURGIA ÓSSEA
COD. 0140 - STILLE DUPLO BIZEL 12 mm P/ CIRURGIA ÓSSEA
COD. 0141 - STILLE DUPLO BIZEL 15 mm P/ CIRURGIA ÓSSEA
COD. 0142 - STILLE DUPLO BIZEL 20 mm P/ CIRURGIA ÓSSEA
COD. 0143 - STILLE DUPLO BIZEL 25 mm P/ CIRURGIA ÓSSEA



COD. 0144 - STILLE GOIVO 8 mm P/ CIRURGIA ÓSSEA
COD. 0145 - STILLE GOIVO 10 mm P/ CIRURGIA ÓSSEA
COD. 0146 - STILLE GOIVO 12 mm P/ CIRURGIA ÓSSEA
COD. 0147 - STILLE GOIVO 15 mm P/ CIRURGIA ÓSSEA
COD. 0148 - STILLE GOIVO 20 mm P/ CIRURGIA ÓSSEA
COD. 0149 - STILLE GOIVO 25 mm P/ CIRURGIA ÓSSEA

GANCHOS

HOOKS

GANCHOS



COD. 1123 - BRAUM 30 cm P/ DECAPITAÇÃO



COD. 1098 - GILLIES DELICADO Nº 1 17 cm
COD. 1099 - GILLIES DELICADO Nº 2 17 cm



COD. 0476 - HARTMAN P/ OUVIDO
E CORPO ESTRANHO 17 cm

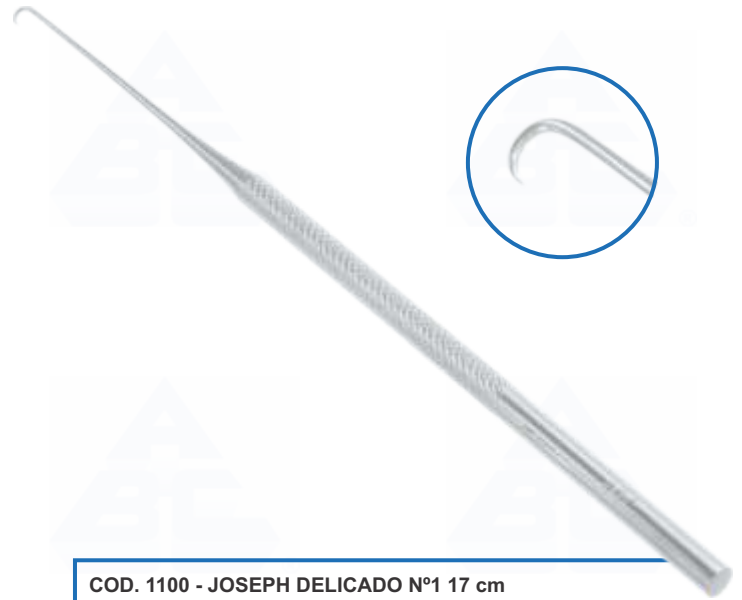

COD. 1100 - JOSEPH DELICADO Nº1 17 cm



COD. 0477 - MODENHAUER P/ OUVIDO
E CORPO ESTRANHO 17 cm



COD. 0478 - ZALFAL P/ OUVIDO
E CORPO ESTRANHO 17 cm

HISTERÔMETROS

UTERINE SOUNDS

HISTERÓMETROS



COD. 0150 - COLLIN 28 cm P/ USO GINECOLÓGICO



COD. 0151 - SIMS 27 cm P/ USO GINECOLÓGICO

MARTELOS

HAMMERS

MARTILLOS



COD. 0431 - BABINSKI 22 cm PERCURSOR



COD. 0152 - BUCK 18 cm PERCURSOR E NEUROLÓGICO



COD. 0153 - DEJERINE 20 cm PERCURSOR E NEUROLÓGICO



COD. 0154 - DEJERINE COM AGULHA PERCURSOR E NEUROLÓGICO

MARTELOS

HAMMERS

MARTILLOS



COD. 0155 - HAJEK 150g P/ CIRURGIA ÓSSEA
COD. 0156 - HAJEK 250g P/ CIRURGIA ÓSSEA



COD. 1001 - MEAD C/ BATENTE DE FIBRA



COD. 0358 - NEUFIELD P/ CIRURGIA ÓSSEA



COD. 0159 - TEYLOR 18 cm
PERCURSOR E NEUROLÓGICO



COD. 0890 - UNIVERSAL 500g P/ CIRURGIA ÓSSEA
COD. 0891 - UNIVERSAL 750g P/ CIRURGIA ÓSSEA



COD. 0157 - WILLIGER 250g P/ CIRURGIA ÓSSEA
COD. 0158 - WILLIGER 350g P/ CIRURGIA ÓSSEA

MENISCÓTOMOS

MENISCOTOMES

MENISCÓTOMOS



COD. 0937 - SMILLIE DIREITO 17 cm
P/ CIRURGIA ÓSSEA



COD. 0938 - SMILLIE ESQUERDO 17 cm
P/ CIRURGIA ÓSSEA

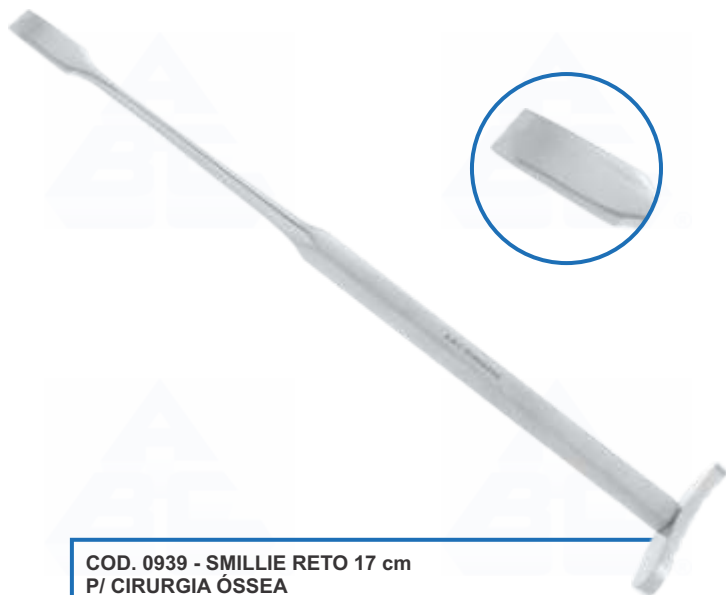

COD. 0939 - SMILLIE RETO 17 cm
P/ CIRURGIA ÓSSEA

PELVIMETROS

PELVIMETERS

PELVIMETROS

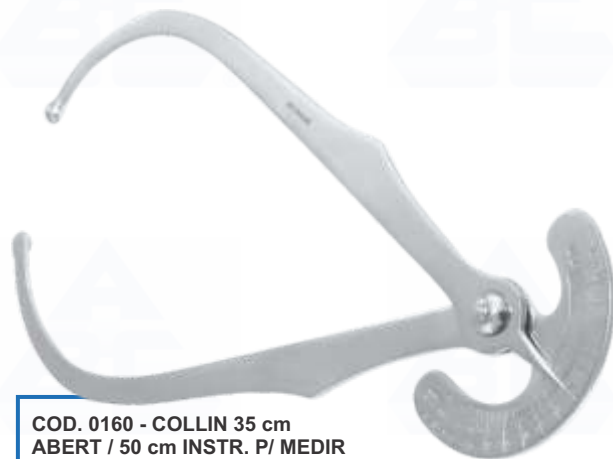

COD. 0160 - COLLIN 35 cm
ABERT / 50 cm INSTR. P/ MEDIR



COD. 0161 - MARTIN 35 cm
ABERT / 50 cm INSTR. P/ MEDIR

PERFURADORES

PERFORATORS

PERFORADORES



COD. 0910 - HUDSON COMPLETO
P/ CIRURGIA ÓSSEA

PERFURADORES

PERFORATORS

PERFORADORES

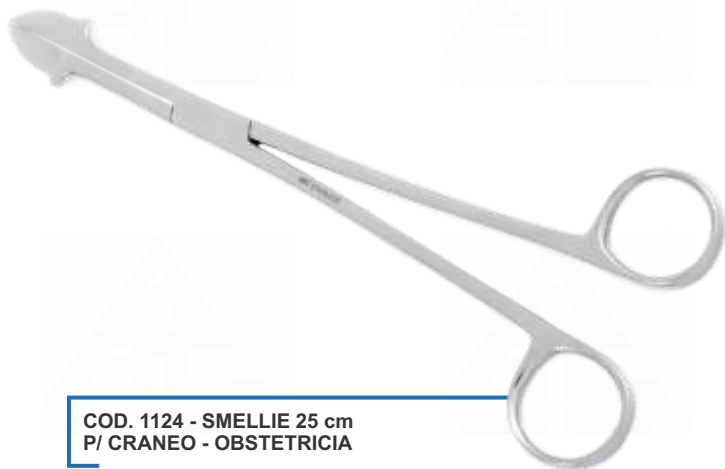

**COD. 1124 - SMELLIE 25 cm
P/ CRANEO - OBSTETRICIA**

PINÇAS

FORCEPS

PINZAS

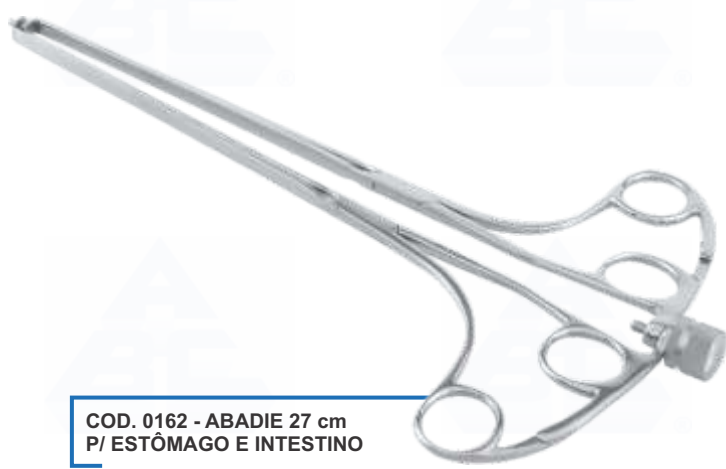

**COD. 0162 - ABADIE 27 cm
P/ ESTÔMAGO E INTESTINO**



**COD. 0163 - ADSON 12 cm COM SERRILHA
COD. 0648 - ADSON 15 cm COM SERRILHA
COD. 1178 - ADSON 18 cm COM SERRILHA**



**COD. 0164 - ADSON 12 cm COM DENTE 1X2
COD. 0649 - ADSON 15 cm COM DENTE 1X2
COD. 1179 - ADSON 18 cm COM DENTE 1X2**

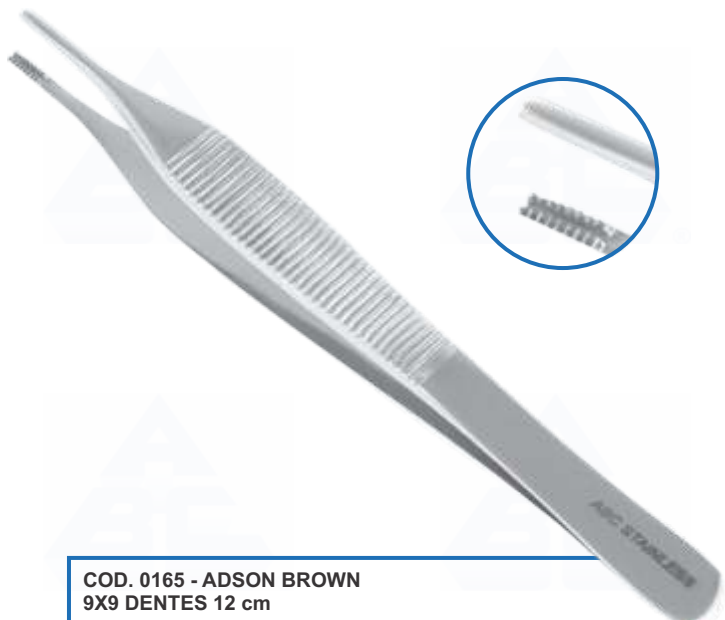

**COD. 0165 - ADSON BROWN
9X9 DENTES 12 cm**



**COD. 0568 - ALLIS BABY 12 cm P/ INTESTINO E TECIDO
COD. 0166 - ALLIS 15 cm P/ INTESTINO E TECIDO
COD. 0167 - ALLIS 18 cm P/ INTESTINO E TECIDO
COD. 0168 - ALLIS 20 cm P/ INTESTINO E TECIDO
COD. 0169 - ALLIS 25 cm P/ INTESTINO E TECIDO**

PINÇAS

FORCEPS

PINZAS



COD. 0651 - ANATÔMICA DISSECÇÃO 10 cm
 COD. 0170 - ANATÔMICA DISSECÇÃO 12 cm
 COD. 0171 - ANATÔMICA DISSECÇÃO 14 cm
 COD. 0172 - ANATÔMICA DISSECÇÃO 16 cm
 COD. 0173 - ANATÔMICA DISSECÇÃO 18 cm
 COD. 0174 - ANATÔMICA DISSECÇÃO 20 cm
 COD. 0175 - ANATÔMICA DISSECÇÃO 25 cm
 COD. 1162 - ANATÔMICA DISSECÇÃO 30 cm



COD. 0652 - ANATÔMICA DENTE DE RATO 10 cm
 COD. 0176 - ANATÔMICA DENTE DE RATO 12 cm
 COD. 0177 - ANATÔMICA DENTE DE RATO 14 cm
 COD. 0178 - ANATÔMICA DENTE DE RATO 16 cm
 COD. 0179 - ANATÔMICA DENTE DE RATO 18 cm
 COD. 0180 - ANATÔMICA DENTE DE RATO 20 cm
 COD. 0181 - ANATÔMICA DENTE DE RATO 25 cm
 COD. 1163 - ANATÔMICA DENTE DE RATO 30 cm



COD. 0424 - ANATÔMICA PONTA FINA 12 cm
 COD. 0425 - ANATÔMICA PONTA FINA 14 cm
 COD. 0426 - ANATÔMICA PONTA FINA 16 cm



COD. 0647 - ASCH 23 cm
 P/ SEPTO E CIRURGIA PLÁSTICA



COD. 0433 - AUTO CENTRANTE 16 cm
 COD. 0434 - AUTO CENTRANTE 19 cm
 COD. 0435 - AUTO CENTRANTE 24 cm
 COD. 0436 - AUTO CENTRANTE 26 cm
 COD. 0437 - AUTO CENTRANTE 28 cm



COD. 0555 - AUXILIAR DE SUTURA 15 cm

PINÇAS

FORCEPS

PINZAS

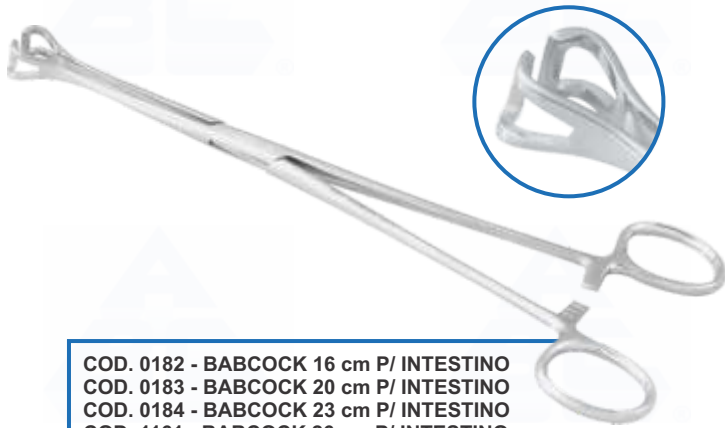

COD. 0182 - BABCOCK 16 cm P/ INTESTINO
 COD. 0183 - BABCOCK 20 cm P/ INTESTINO
 COD. 0184 - BABCOCK 23 cm P/ INTESTINO
 COD. 1161 - BABCOCK 26 cm P/ INTESTINO

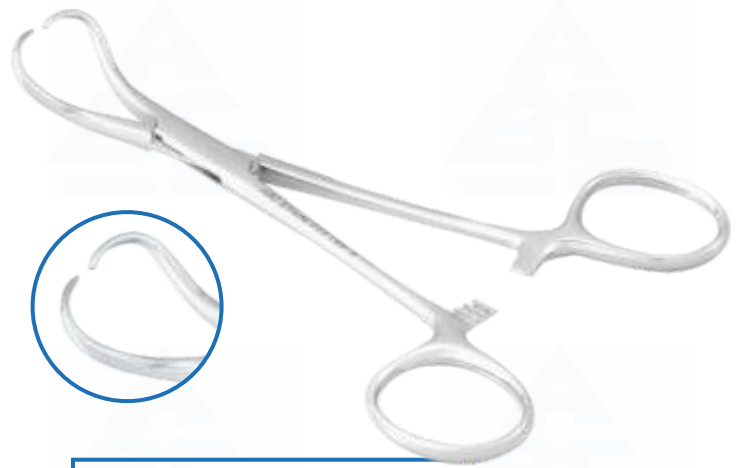

COD. 0661 - BACKHAUS 8 cm P/ CAMPO
 COD. 0185 - BACKHAUS 10 cm P/ CAMPO
 COD. 0186 - BACKHAUS 13 cm P/ CAMPO
 COD. 1180 - BACKHAUS 15 cm P/ CAMPO



COD. 0187 - BERNHARD 16 cm P/ CAMPO



COD. 1072 - BEYER 18 cm CURVA
 DUPLA ARTICULAÇÃO



COD. 0611 - BEYER 18 cm SACA BOCADO
 P/ CAVIDADE



COD. 0521 - BISHOP 8 cm C/ SERRILHA RETA
 P/ MICRO CIRURGIA

PINÇAS

FORCEPS

PINZAS

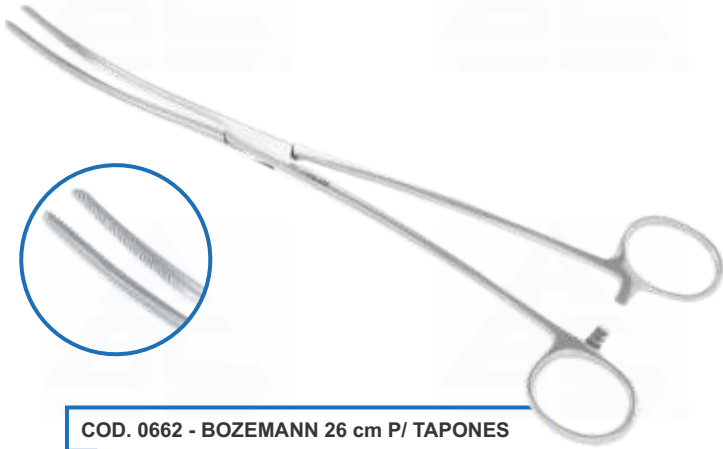

COD. 0662 - BOZEMANN 26 cm P/ TAPONES

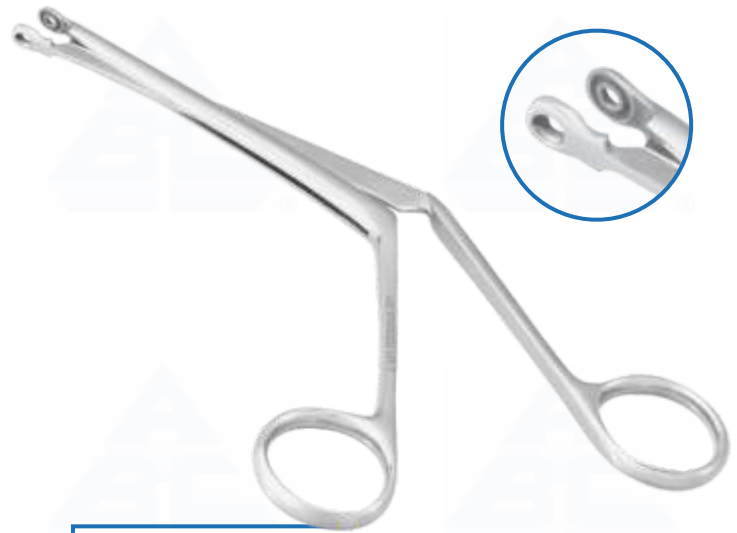

COD. 0188 - BRUENINGS Nº1 19 cm P/ SEPTO NASAL
 COD. 0189 - BRUENINGS Nº2 19 cm P/ SEPTO NASAL



COD. 0190 - BULLDOG 4 cm RETA DIEFFENBACH
 COD. 0192 - BULLDOG 5 cm RETA DIEFFENBACH
 COD. 0194 - BULLDOG 6 cm RETA DIEFFENBACH



COD. 0191 - BULLDOG 4 cm CURVA DIEFFENBACH
 COD. 0193 - BULLDOG 5 cm CURVA DIEFFENBACH
 COD. 0195 - BULLDOG 6 cm CURVA DIEFFENBACH



COD. 0196 - CHERON 24 cm P/ ASSEPSIA
 E CURATIVO UTERINO



COD. 0997 - CHEVALIER JACKSON P/ BIOPSIA 40 cm
 COD. 0998 - CHEVALIER JACKSON P/ BIOPSIA 50 cm

PINÇAS

FORCEPS

PINZAS



COD. 0999 - CHEVALIER JACKSON TIPO JACARÉ 40 cm
 COD. 1000 - CHEVALIER JACKSON TIPO JACARÉ 50 cm

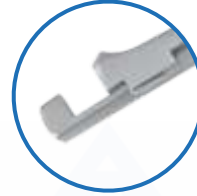
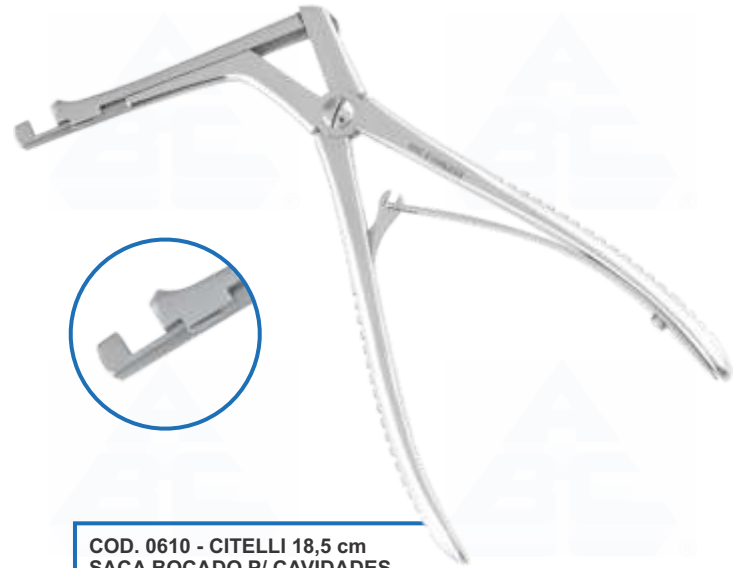

COD. 0610 - CITELLI 18,5 cm
 SACA BOCADO P/ CAVIDADES



COD. 0438 - CLAMP DE FIXAÇÃO ÓSSEA 160 mm (ESPAÑHOLA)
 COD. 0439 - CLAMP DE FIXAÇÃO ÓSSEA 220 mm (ESPAÑHOLA)



COD. 0197 - CLINICA P/ ALGODÃO Nº 17
 COD. 0554 - CLINICA 13 cm P/ ODONTOPEDIATRIA
 P/ ALGODÃO

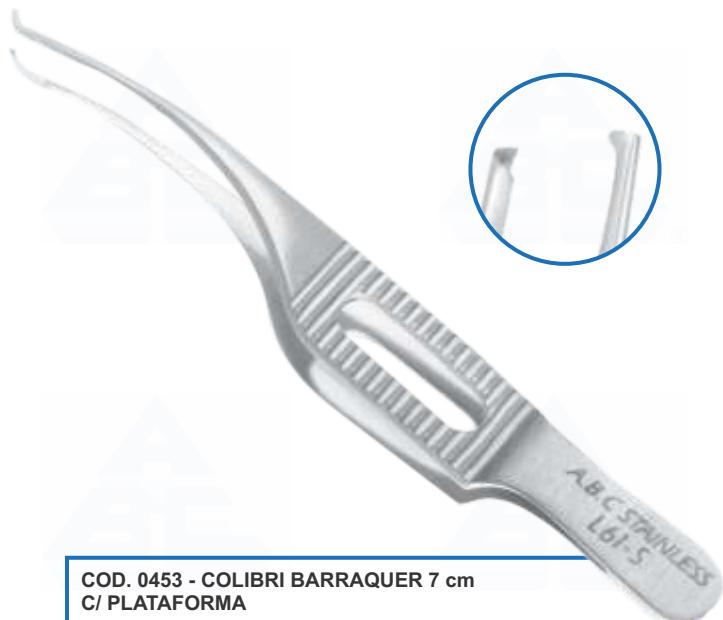

COD. 0453 - COLIBRI BARRAQUER 7 cm
 C/ PLATAFORMA



COD. 0199 - COLLIN CORAÇÃO 16 cm
 TIRA LINGUA

PINÇAS

FORCEPS

PINZAS



COD. 0198 - COLLIN 25 cm
P/ CURATIVO UTERINO



COD. 0471 - COLLIN 20 cm P/ INSTRUMENTOS 1X2
COD. 0472 - COLLIN 25 cm P/ INSTRUMENTOS 1X2



COD. 1159 - COLLIN OVAL 16 cm
TIRA LINGUA



COD. 0613 - COTTLE WALSHAM DIREITA 23 cm
P/ SEPTO E PLÁSTICA



COD. 0614 - COTTLE WALSHAM ESQUERDA 23 cm
P/ SEPTO E PLÁSTICA



COD. 0615 - COTTLE WALSHAM RETA 23 cm
P/ SEPTO E PLÁSTICA

PINÇAS

FORCEPS

PINZAS



COD. 0664 - CRAFOORD 24 cm
RETA P/ BRONQUIOS



COD. 0665 - CRAFOORD 24 cm CURVA
P/ BRONQUIOS



COD. 0203 - CRILE 14 cm RETA (HEMOSTÁTICA)
COD. 0205 - CRILE 16 cm RETA (HEMOSTÁTICA)

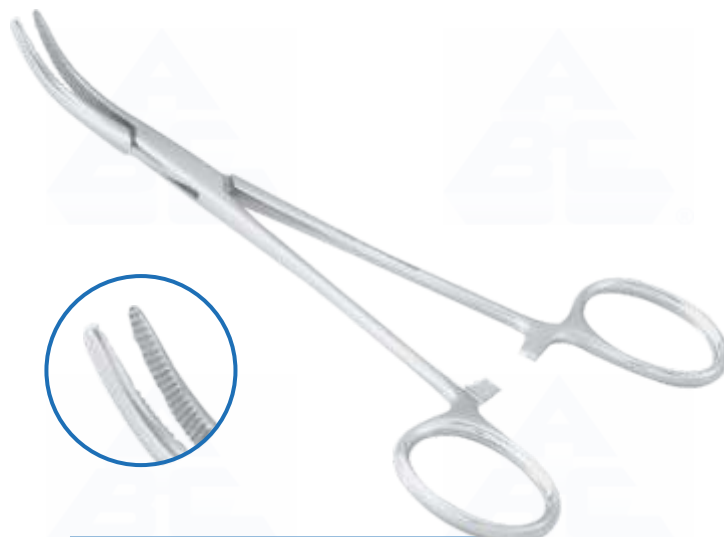

COD. 0204 - CRILE 14 cm CURVA (HEMOSTÁTICA)
COD. 0206 - CRILE 16 cm CURVA (HEMOSTÁTICA)



COD. 0653 - CUSHING 18 cm COM SERRILHA



COD. 0654 - CUSHING 18 cm COM DENTE 1X2

PINÇAS

FORCEPS

PINZAS



COD. 0132 - DANDY 14 cm (HEMOSTÁTICA)



COD. 0207 - DARTIGUES P/ ÚTERO 24 cm

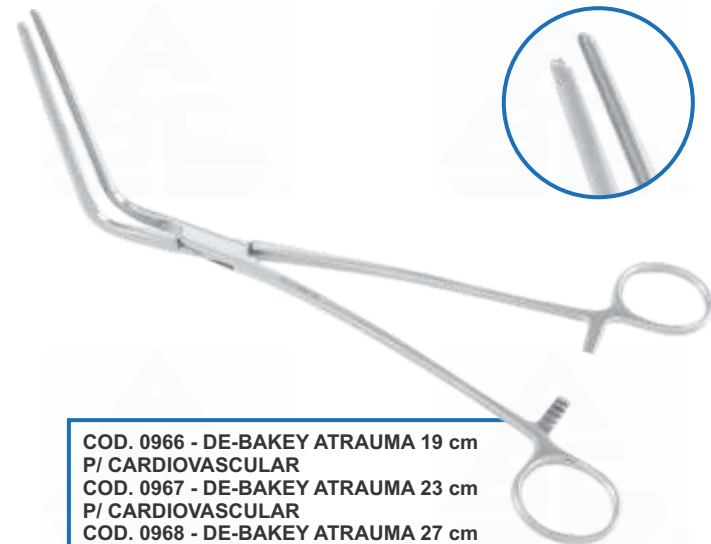

COD. 0966 - DE-BAKEY ATRAUMA 19 cm
P/ CARDIOVASCULAR
COD. 0967 - DE-BAKEY ATRAUMA 23 cm
P/ CARDIOVASCULAR
COD. 0968 - DE-BAKEY ATRAUMA 27 cm
P/ CARDIOVASCULAR

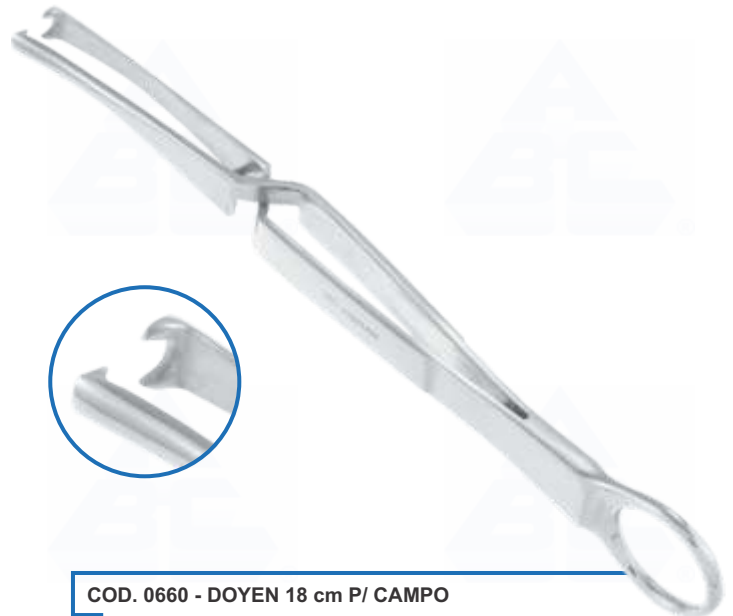

COD. 0660 - DOYEN 18 cm P/ CAMPO



COD. 0954 - DOYEN-ATRAUMA RETA 16 cm
GASTRO-INTESTINAL
COD. 0955 - DOYEN-ATRAUMA RETA 18 cm
GASTRO-INTESTINAL
COD. 0956 - DOYEN-ATRAUMA RETA 21 cm
GASTRO-INTESTINAL
COD. 0957 - DOYEN-ATRAUMA RETA 23 cm
GASTRO-INTESTINAL



COD. 0958 - DOYEN-ATRAUMA CURVA 16 cm
GASTRO-INTESTINAL
COD. 0959 - DOYEN-ATRAUMA CURVA 18 cm
GASTRO-INTESTINAL
COD. 0960 - DOYEN-ATRAUMA CURVA 21 cm
GASTRO-INTESTINAL
COD. 0961 - DOYEN-ATRAUMA CURVA 23 cm
GASTRO-INTESTINAL



PINÇAS

FORCEPS

PINZAS



**COD. 0208 - DOYEN 25 cm RETA
INTESTINAL E COPROSTASI**

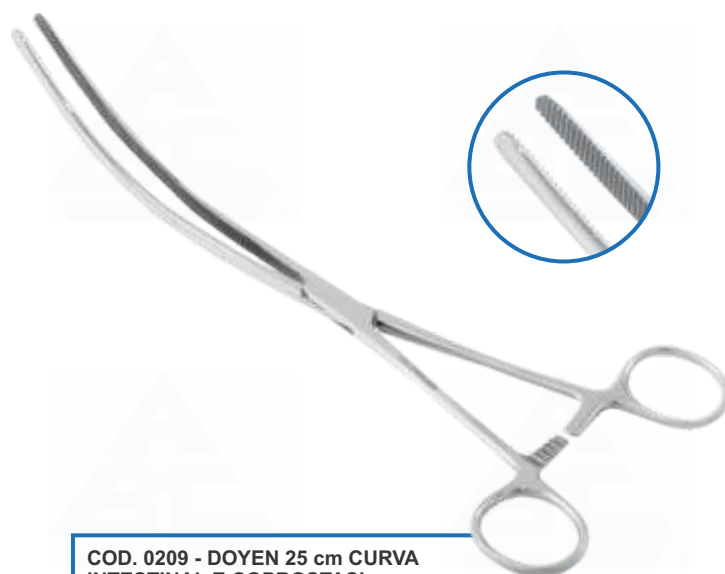

**COD. 0209 - DOYEN 25 cm CURVA
INTESTINAL E COPROSTASI**



**COD. 0210 - DOYEN-BABY 18 cm RETA
INTESTINAL E COPROSTASI
COD. 0211 - DOYEN-BABY 18 cm CURVA
INTESTINAL E COPROSTASI**



COD. 0432 - DUCK BILL GOIVA 23 cm



**COD. 0253 - DUVAL COLLIN 20 cm
P/ INTESTINO**



**COD. 0212 - FARABEUF LAMBOTTE 26 cm
S/ CREMALHEIRA P/ OSSO**

PINÇAS

FORCEPS

PINZAS



**COD. 0213 - FARABEU F LAMBOTTE 26 cm
C/ CREMALHEIRA P/ OSO**



**COD. 0402 - FARABEU F VAN-BUREN
23 cm P/ CIRURGIA ÓSSEA**



COD. 0214 - FAURE 22 cm P/ ARTÉRIA UTERINA



COD. 0215 - FAURE 24 cm P/ BIOPSIA UTERINA



COD. 0403 - FERGUSSON 21 cm P/ CIRURGIA ÓSSEA

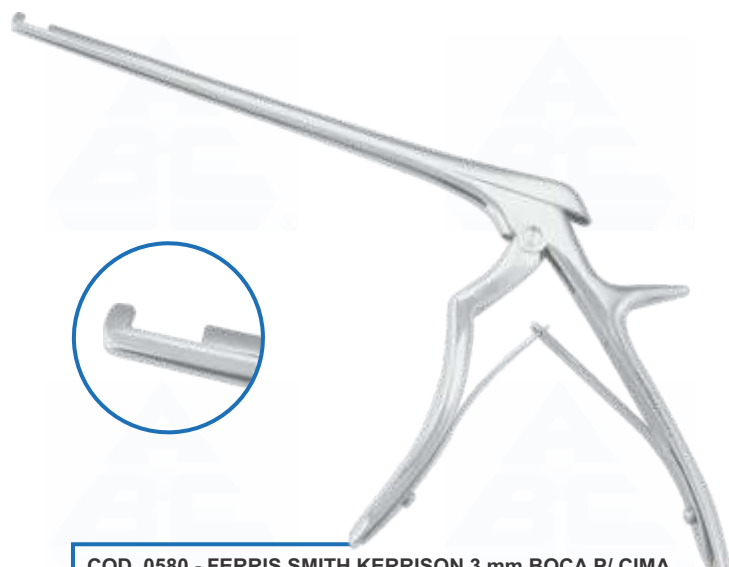

**COD. 0580 - FERRIS SMITH KERRISON 3 mm BOCA P/ CIMA
COD. 0581 - FERRIS SMITH KERRISON 5 mm BOCA P/ CIMA**

PINÇAS

FORCEPS

PINZAS



COD. 0582 - FERRIS SMITH KERRISON 3 mm BOCA P/ BAIXO
 COD. 0583 - FERRIS SMITH KERRISON 5 mm BOCA P/ BAIXO

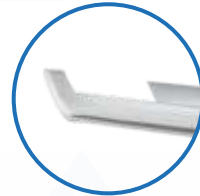
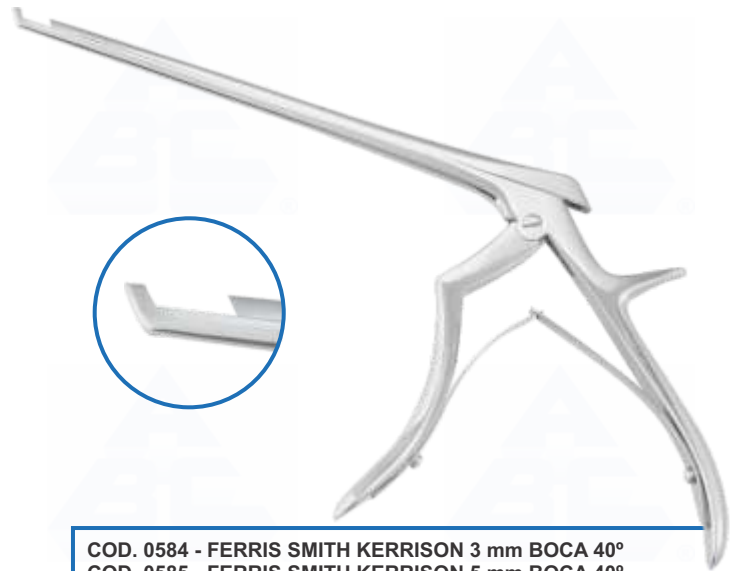

COD. 0584 - FERRIS SMITH KERRISON 3 mm BOCA 40°
 COD. 0585 - FERRIS SMITH KERRISON 5 mm BOCA 40°



COD. 0667 - FOERSTER 16 cm RETA P/ CURATIVO
 COD. 0216 - FOERSTER 18 cm RETA P/ CURATIVO
 COD. 0669 - FOERSTER 20 cm RETA P/ CURATIVO
 COD. 0218 - FOERSTER 24 cm RETA P/ CURATIVO



COD. 0668 - FOERSTER 16 cm CURVA P/ CURATIVO
 COD. 0217 - FOERSTER 18 cm CURVA P/ CURATIVO
 COD. 0670 - FOERSTER 20 cm CURVA P/ CURATIVO
 COD. 0219 - FOERSTER 24 cm CURVA P/ CURATIVO



COD. 0946 - GLOVER 6 cm RETA
 ATRAUMÁTICA P/ CARDIOVASCULAR
 COD. 0947 - GLOVER 7 cm RETA
 ATRAUMÁTICA P/ CARDIOVASCULAR
 COD. 0948 - GLOVER 9 cm RETA
 ATRAUMÁTICA P/ CARDIOVASCULAR
 COD. 0949 - GLOVER 11 cm RETA
 ATRAUMÁTICA P/ CARDIOVASCULAR



COD. 0950 - GLOVER 6 cm CURVA
 ATRAUMÁTICA P/ CARDIOVASCULAR
 COD. 0951 - GLOVER 7 cm CURVA
 ATRAUMÁTICA P/ CARDIOVASCULAR
 COD. 0952 - GLOVER 9 cm CURVA
 ATRAUMÁTICA P/ CARDIOVASCULAR
 COD. 0953 - GLOVER 11 cm CURVA
 ATRAUMÁTICA P/ CARDIOVASCULAR

PINÇAS

FORCEPS

PINZAS



**COD. 0618 - GRUENWALD 26 cm BOCA RETA
P/ NEURO E LAMINECTOMIA**



**COD. 0619 - GRUENWALD 26 cm BOCA P/ CIMA
P/ NEURO E LAMINECTOMIA**



**COD. 0620 - GRUENWALD 26 cm BOCA P/ BAIXO
P/ NEURO E LAMINECTOMIA**



**COD. 1042 - GUYON 16 cm P/ PEDICULO RENAL
COD. 0220 - GUYON 22 cm P/ PEDICULO RENAL
COD. 0221 - GUYON 24 cm P/ PEDICULO RENAL**



**COD. 0222 - HALSTEAD MOSQUITO 10 cm
RETA (HEMOSTATICA)
COD. 0224 - HALSTEAD MOSQUITO 12 cm
RETA (HEMOSTATICA)
COD. 0427 - HALSTEAD MOSQUITO 18 cm
RETA (HEMOSTATICA)
COD. 0429 - HALSTEAD MOSQUITO 21 cm
RETA (HEMOSTATICA)**



**COD. 0223 - HALSTEAD MOSQUITO 10 cm
CURVA (HEMOSTATICA)
COD. 0225 - HALSTEAD MOSQUITO 12 cm
CURVA (HEMOSTATICA)
COD. 0428 - HALSTEAD MOSQUITO 18 cm
CURVA (HEMOSTATICA)
COD. 0430 - HALSTEAD MOSQUITO 21 cm
CURVA (HEMOSTATICA)**

PINÇAS

FORCEPS

PINZAS



COD. 1142 - HARTMANN MICRO 8 cm RETA AURICULAR

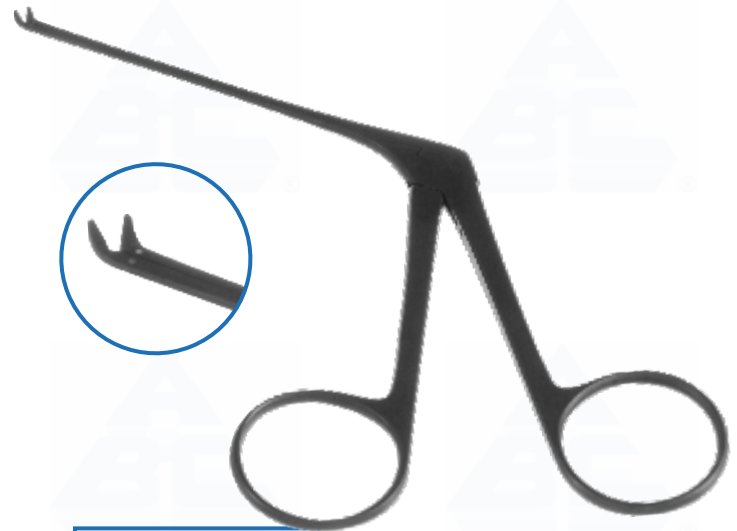

COD. 1143 - HARTMANN MICRO 8 cm CURVA P/ CIMA AURICULAR



COD. 1144 - HARTMANN MICRO 8 cm CURVA P/ DIREITA AURICULAR



COD. 1145 - HARTMANN MICRO 8 cm CURVA P/ ESQUERDA AURICULAR



COD. 0226 - HARTMANN 15 cm P/ CURATIVO AURICULAR
 COD. 0227 - HARTMANN 19 cm P/ CURATIVO AURICULAR



COD. 0228 - HARTMANN 9 cm P/ CORPO ESTRANHO C/ SERRILHA
 COD. 0557 - HARTMANN 14 cm P/ CORPO ESTRANHO C/ SERRILHA
 COD. 0578 - HARTMANN 16,5 cm P/ CORPO ESTRANHO C/ SERRILHA

PINÇAS

FORCEPS

PINZAS



COD. 0229 - HARTMANN 9 cm P/ CORPO ESTRANHO C/ DENTE



COD. 0064 - HARTMANN 20 cm P/ CORPO ESTRANHO C/ SERRILHA
 COD. 0065 - HARTMANN 28 cm P/ CORPO ESTRANHO C/ SERRILHA



COD. 0424 - HISTOLOGICA PONTA FINA 12 cm P/ USO GERAL
 COD. 0425 - HISTOLOGICA PONTA FINA 14 cm P/ USO GERAL
 COD. 0426 - HISTOLOGICA PONTA FINA 16 cm P/ USO GERAL



COD. 0666 - JONES 9 cm P/ CAMPO

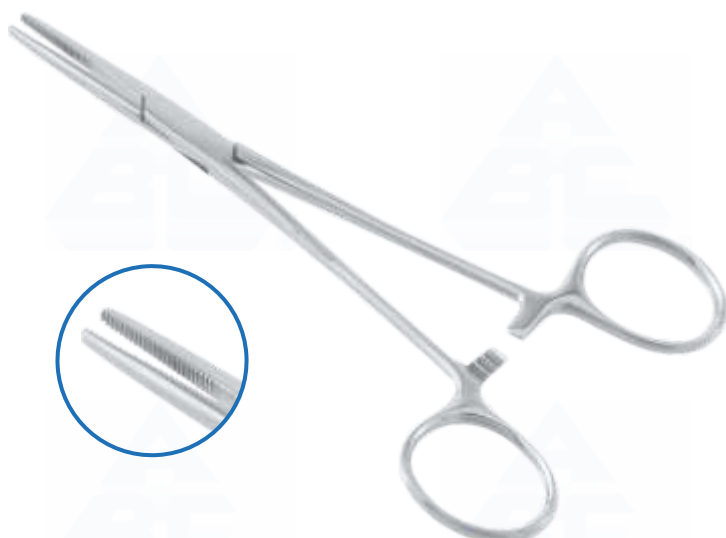

COD. 0231 - KELLY 14 cm RETA (HEMOSTATICA)
 COD. 0233 - KELLY 16 cm RETA (HEMOSTATICA)
 COD. 0376 - KELLY 18 cm RETA (HEMOSTATICA)



COD. 0232 - KELLY 14 cm CURVA (HEMOSTATICA)
 COD. 0234 - KELLY 16 cm CURVA (HEMOSTATICA)
 COD. 0377 - KELLY 18 cm CURVA (HEMOSTATICA)

PINÇAS

FORCEPS

PINZAS



COD. 0586 - KERRISON 20 cm
BOCA 4x4 mm P/ MAXILAR E ADENOIDES
COD. 0587 - KERRISON 20 cm
BOCA 5x5 mm P/ MAXILAR E ADENOIDES
COD. 0588 - KERRISON 20 cm
BOCA 6x6 mm P/ MAXILAR E ADENOIDES



COD. 0235 - KOCHER 14 cm RETA (HEMOSTATICA)
COD. 0237 - KOCHER 16 cm RETA (HEMOSTATICA)
COD. 0239 - KOCHER 18 cm RETA (HEMOSTATICA)
COD. 0241 - KOCHER 20 cm RETA (HEMOSTATICA)
COD. 1168 - KOCHER 22 cm RETA (HEMOSTATICA)
COD. 1170 - KOCHER 24 cm RETA (HEMOSTATICA)
COD. 1172 - KOCHER 26 cm RETA (HEMOSTATICA)
COD. 1174 - KOCHER 30 cm RETA (HEMOSTATICA)



COD. 0236 - KOCHER 14 cm CURVA (HEMOSTATICA)
COD. 0238 - KOCHER 16 cm CURVA (HEMOSTATICA)
COD. 0240 - KOCHER 18 cm CURVA (HEMOSTATICA)
COD. 0242 - KOCHER 20 cm CURVA (HEMOSTATICA)
COD. 1169 - KOCHER 22 cm CURVA (HEMOSTATICA)
COD. 1171 - KOCHER 24 cm CURVA (HEMOSTATICA)
COD. 1173 - KOCHER 26 cm CURVA (HEMOSTATICA)
COD. 1175 - KOCHER 30 cm CURVA (HEMOSTATICA)



COD. 0243 - KOCHER 25 cm RETA
INTESTINAL E COPROSTASI



COD. 0244 - KOCHER 25 cm CURVA
INTESTINAL E COPROSTASI



COD. 0962 - KOCHER - ATRAUMA RETA 25 cm
GASTRO - INTESTINAL
COD. 0963 - KOCHER - ATRAUMA RETA 28 cm
GASTRO - INTESTINAL

PINÇAS

FORCEPS

PINZAS



COD. 0964 - KOCHER - ATRAUMA RETA 25 cm
GASTRO - INTESTINAL
COD. 0965 - KOCHER - ATRAUMA RETA 28 cm
GASTRO - INTESTINAL



COD. 0393 - LAMBOTTE 21 cm C/ BOCA MÓVEL P/ CIR. ÓSSEA
COD. 0394 - LAMBOTTE 26 cm C/ BOCA MÓVEL P/ CIR. ÓSSEA
COD. 0395 - LAMBOTTE 31 cm C/ BOCA MÓVEL P/ CIR. ÓSSEA



COD. 0245 - LANE 33 cm S/ CREMALHEIRA
P/ CIRURGIA ÓSSEA



COD. 0246 - LANE 33 cm C/ CREMALHEIRA
P/ CIRURGIA ÓSSEA



COD. 0247 - LEKSELL EM ÂNGULO 24 cm
P/ CIRURGIA ÓSSEA



COD. 1176 - LOWMANN PEQUENA 12 cm P/ OSSOS
COD. 1177 - LOWMANN PEQUENA 15 cm P/ OSSOS
COD. 0248 - LOWMANN PEQUENA 17 cm P/ OSSOS
COD. 0249 - LOWMANN MÉDIA 18,5 cm P/ OSSOS
COD. 0250 - LOWMANN GRANDE 20 cm P/ OSSOS

PINÇAS

FORCEPS

PINZAS



COD. 0062 - LUCAE BAIONETA 14,5 cm
P/ CURATIVO AURICULAR
COD. 0063 - LUCAE BAIONETA 16,5 cm
P/ CURATIVO AURICULAR



COD. 0591 - LUER GOIVA 17 cm RETA
SIMPLES P/ OSSO



COD. 0592 - LUER GOIVA 17 cm CURVA
SIMPLES P/ OSSO



COD. 0032 - LUER GOIVA 23 cm RETA
DUPLA ARTICULAÇÃO



COD. 0033 - LUER GOIVA 23 cm CURVA
DUPLA ARTICULAÇÃO



COD. 1158 - MAGIL 15 cm P/ INTRODUÇÃO DE CATETER
COD. 0251 - MAGIL 20 cm P/ INTRODUÇÃO DE CATETER
COD. 0252 - MAGIL 25 cm P/ INTRODUÇÃO DE CATETER

PINÇAS

FORCEPS

PINZAS



COD. 0387 - MARTIN 19 cm P/ MENISCO

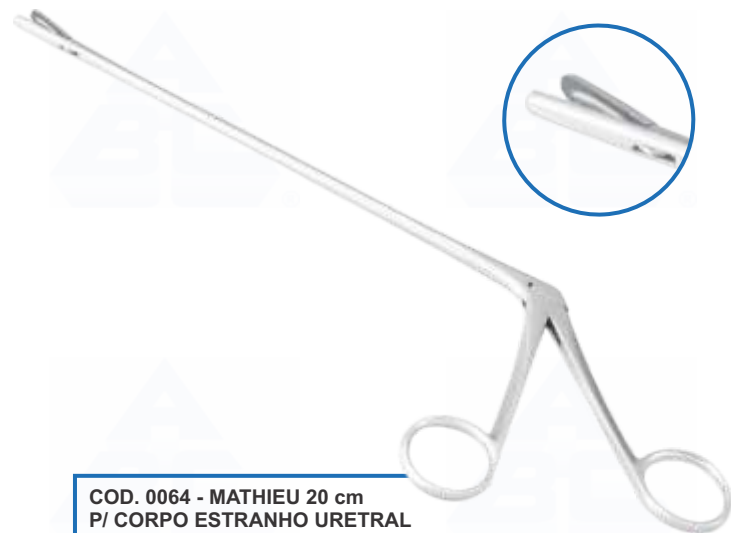

COD. 0064 - MATHIEU 20 cm
P/ CORPO ESTRANHO URETRAL
COD. 0065 - MATHIEU 28 cm
P/ CORPO ESTRANHO URETRAL



COD. 0066 - MATHIEU 20 cm P/ BIOPSIA URETRAL
COD. 0067 - MATHIEU 28 cm P/ BIOPSIA URETRAL



COD. 0036 - MENKEN OU KOGAN 27 cm
P/ ABERTURA DO COLO DO ÚTERO



COD. 0254 - MICHEL 12,5 cm P/ RETIRAR E
COLOCAR AGRAFES

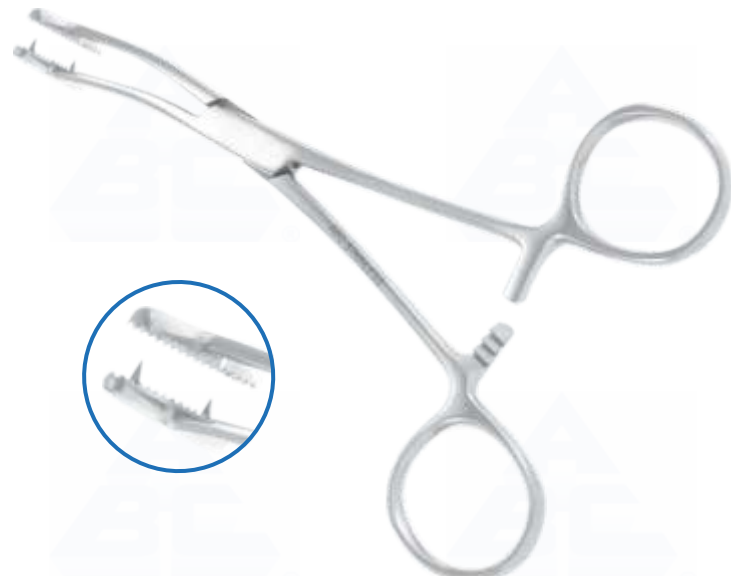

COD. 0659 - MARTEL 14 cm P/ PERICLANIO

PINÇAS

FORCEPS

PINZAS



COD. 0372 - MIXTER BABY 14 cm (HEMOSTÁTICA)
 COD. 0373 - MIXTER BABY 16 cm (HEMOSTÁTICA)
 COD. 0255 - MIXTER 18 cm (HEMOSTÁTICA)
 COD. 0256 - MIXTER 20 cm (HEMOSTÁTICA)
 COD. 0257 - MIXTER 22 cm (HEMOSTÁTICA)
 COD. 0258 - MIXTER 24 cm (HEMOSTÁTICA)

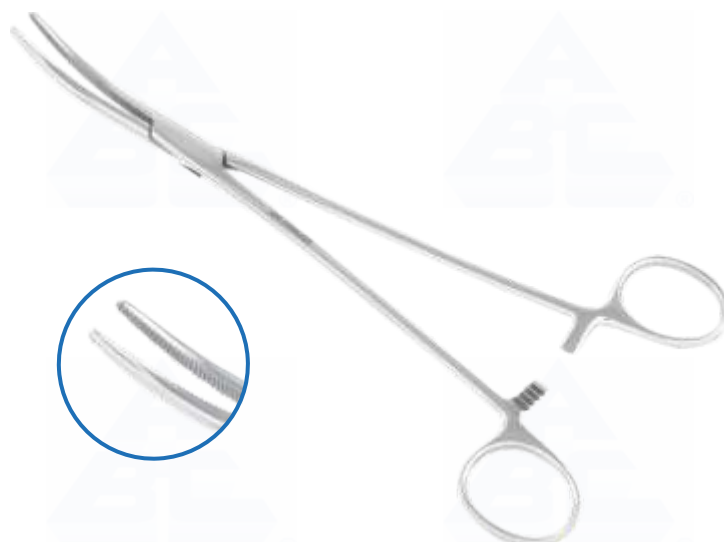

COD. 0259 - MOYNIHAN 24 cm P/ HISTERECTOMIA



COD. 0230 - MUSEUX RETA 24 cm OU JACOBS
 P/ COLO UTERINO



COD. 1160 - MUSEUX CURVA 24 cm OU JACOBS
 P/ COLO UTERINO

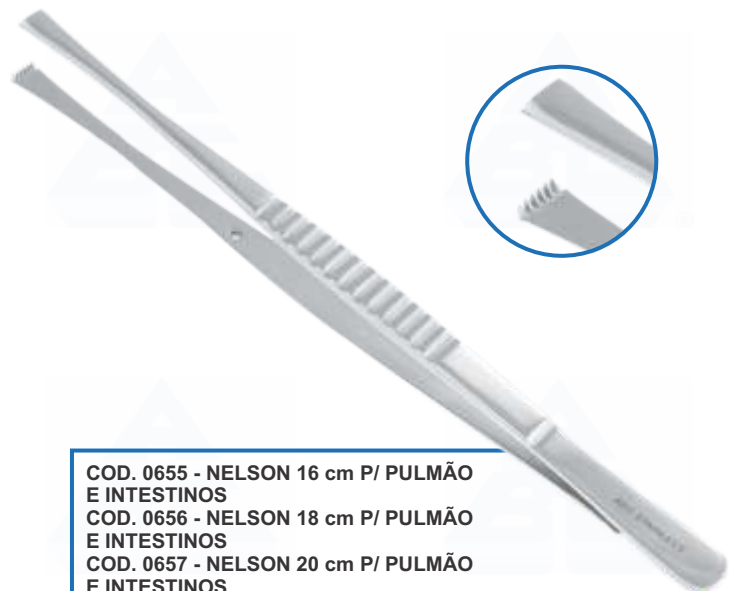

COD. 0655 - NELSON 16 cm P/ PULMÃO
 E INTESTINOS
 COD. 0656 - NELSON 18 cm P/ PULMÃO
 E INTESTINOS
 COD. 0657 - NELSON 20 cm P/ PULMÃO
 E INTESTINOS



COD. 1146 - PINÇA PARA BIOPSIA MICRO 8 cm
 RETA AURICULAR

PINÇAS

FORCEPS

PINZAS



**COD. 1147 - PINÇA PARA BIOPSIA MICRO 8 cm
CURVA P/ CIMA AURICULAR**

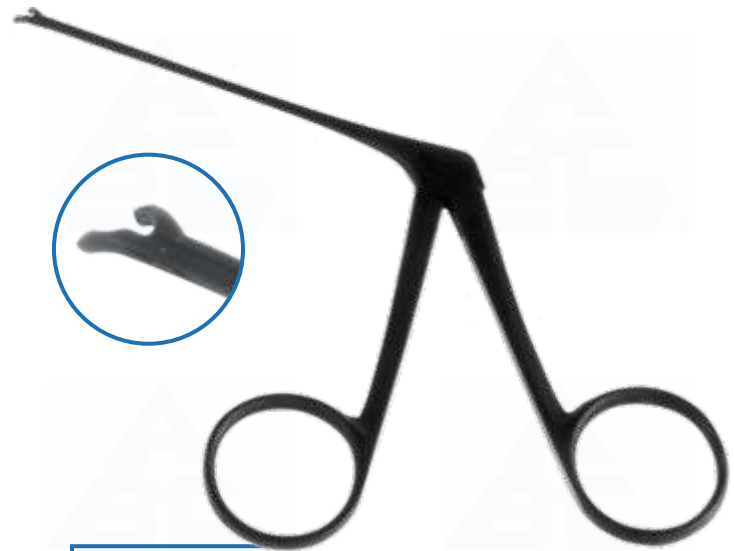

**COD. 1148 - PINÇA PARA BIOPSIA MICRO 8 cm
CURVA P/ DIREITA AURICULAR**



**COD. 1149 - PINÇA PARA BIOPSIA MICRO 8 cm
CURVA P/ ESQUERDA AURICULAR**



**COD. 0260 - PATA DE GATO (RUSSA) 15 cm
P/ TECIDO**
**COD. 0261 - PATA DE GATO (RUSSA) 20 cm
P/ TECIDO**



**COD. 0262 - PAYR 20 cm CLAMP
P/ ESTÔMAGO E INTESTINO**
**COD. 0263 - PAYR 29 cm CLAMP
P/ ESTÔMAGO E INTESTINO**
**COD. 0264 - PAYR 35 cm CLAMP
P/ ESTÔMAGO E INTESTINO**



COD. 0265 - PEAN 14 cm (HEMOSTÁTICA E CURATIVO)
COD. 0266 - PEAN 16 cm (HEMOSTÁTICA E CURATIVO)

PINÇAS

FORCEPS

PINZAS



COD. 0267 - PELKMANN 24 cm
P/ CURATIVO UTERINO



COD. 1044 - PENNINGTON 15 cm TRIANGULAR (HEMOSTATICA)
COD. 0658 - PENNINGTON 20 cm TRIANGULAR (HEMOSTATICA)



COD. 0553 - PERRY 13 cm

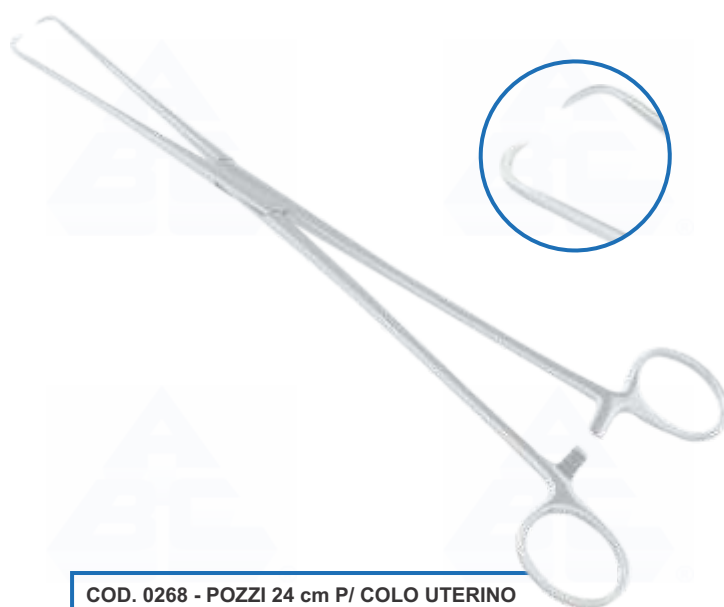

COD. 0268 - POZZI 24 cm P/ COLO UTERINO

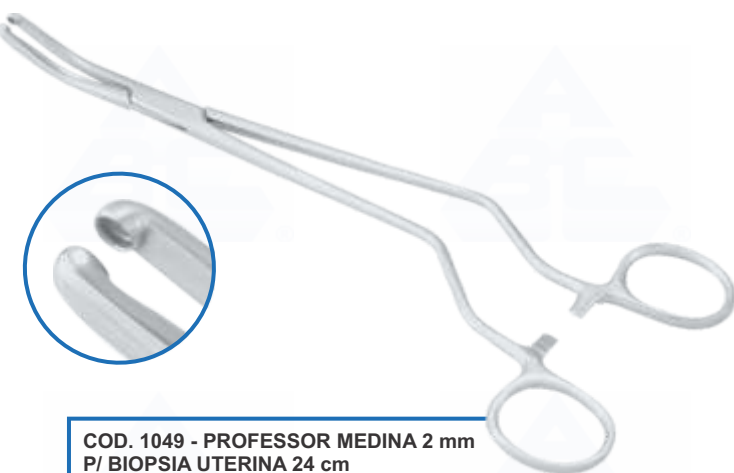

COD. 1049 - PROFESSOR MEDINA 2 mm
P/ BIOPSIA UTERINA 24 cm
COD. 0269 - PROFESSOR MEDINA 3 mm
P/ BIOPSIA UTERINA 24 cm
COD. 0637 - PROFESSOR MEDINA 4 mm
P/ BIOPSIA UTERINA 24 cm
COD. 0638 - PROFESSOR MEDINA 5 mm
P/ BIOPSIA UTERINA 24 cm

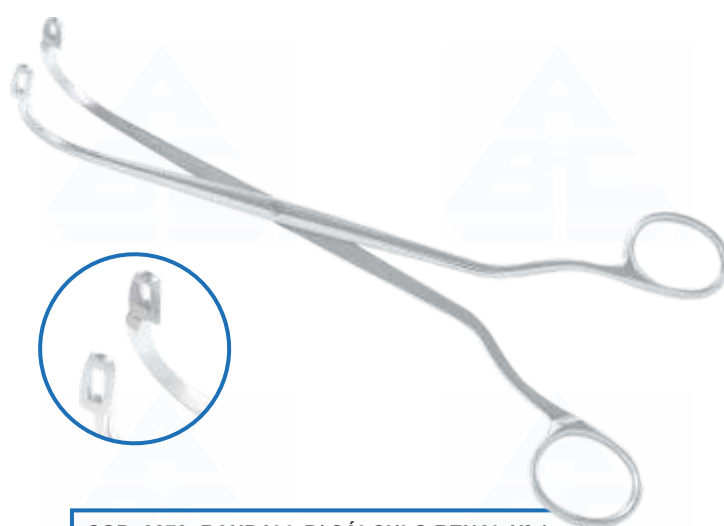

COD. 0270 - RANDALL P/ CÁLCULO RENAL Nº 1
COD. 0271 - RANDALL P/ CÁLCULO RENAL Nº 2
COD. 0272 - RANDALL P/ CÁLCULO RENAL Nº 3
COD. 0273 - RANDALL P/ CÁLCULO RENAL Nº 4

PINÇAS

FORCEPS

PINZAS



COD. 0365 - REINOLD P/ TUBO 18 cm (P/ HEMODIALISE)

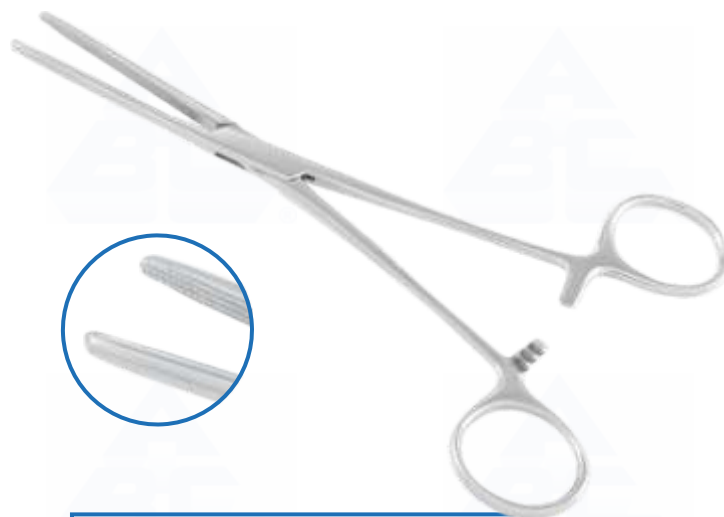

**COD. 0900 - ROCHESTER CARMALT RETA 16 cm (HEMOSTATICA)
COD. 0902 - ROCHESTER CARMALT RETA 18 cm (HEMOSTATICA)
COD. 0904 - ROCHESTER CARMALT RETA 20 cm (HEMOSTATICA)**



**COD. 0901 - ROCHESTER CARMALT CURVA 16 cm (HEMOSTATICA)
COD. 0903 - ROCHESTER CARMALT CURVA 18 cm (HEMOSTATICA)
COD. 0905 - ROCHESTER CARMALT CURVA 20 cm (HEMOSTATICA)**



**COD. 0274 - ROCHESTER PEAN RETA 16 cm (HEMOSTATICA)
COD. 0276 - ROCHESTER PEAN RETA 18 cm (HEMOSTATICA)
COD. 0278 - ROCHESTER PEAN RETA 20 cm (HEMOSTATICA)
COD. 0280 - ROCHESTER PEAN RETA 22 cm (HEMOSTATICA)
COD. 0282 - ROCHESTER PEAN RETA 24 cm (HEMOSTATICA)
COD. 1164 - ROCHESTER PEAN RETA 26 cm (HEMOSTATICA)
COD. 1166 - ROCHESTER PEAN RETA 30 cm (HEMOSTATICA)**



**COD. 0275 - ROCHESTER PEAN CURVA 16 cm (HEMOSTATICA)
COD. 0277 - ROCHESTER PEAN CURVA 18 cm (HEMOSTATICA)
COD. 0279 - ROCHESTER PEAN CURVA 20 cm (HEMOSTATICA)
COD. 0281 - ROCHESTER PEAN CURVA 22 cm (HEMOSTATICA)
COD. 0283 - ROCHESTER PEAN CURVA 24 cm (HEMOSTATICA)
COD. 1165 - ROCHESTER PEAN CURVA 26 cm (HEMOSTATICA)
COD. 1167 - ROCHESTER PEAN CURVA 30 cm (HEMOSTATICA)**



COD. 0284 - ROMPE BOLSA 20 cm

PINÇAS

FORCEPS

PINZAS



**COD. 0616 - ROWE 23,5 cm ESQUERDA
P/ MAXILAR E REDUÇÃO**



**COD. 0617 - ROWE 23,5 cm DIREITA
P/ MAXILAR E REDUÇÃO**



**COD. 0285 - RUSKIN 19 cm CURVA
DUPLA ARTICULAÇÃO**



**COD. 1043 - RUSKIN 19 cm RETA
DUPLA ARTICULAÇÃO**



**COD. 0940 - SATINSKY - BABY/CRUZ 15 cm P/ CARDIOVASCULAR
COD. 0941 - SATINSKY SERR/CRUZADA 18 cm P/ CARDIOVASCULAR
COD. 0942 - SATINSKY SERR/CRUZADA 20 cm P/ CARDIOVASCULAR
COD. 0943 - SATINSKY SERR/CRUZADA 22 cm P/ CARDIOVASCULAR
COD. 0944 - SATINSKY SERR/CRUZADA 24 cm P/ CARDIOVASCULAR
COD. 0945 - SATINSKY SERR/CRUZADA 26 cm P/ CARDIOVASCULAR**



**COD. 0969 - SATINSKY - ATRAUMA 20 cm
P/ CARDIOVASCULAR
COD. 0970 - SATINSKY - ATRAUMA 24 cm
P/ CARDIOVASCULAR
COD. 0971 - SATINSKY - ATRAUMA 26 cm
P/ CARDIOVASCULAR**

PINÇAS

FORCEPS

PINZAS



**COD. 0380 - SCHIMIDT 18 cm RETA
P/ AMIGDALAS**

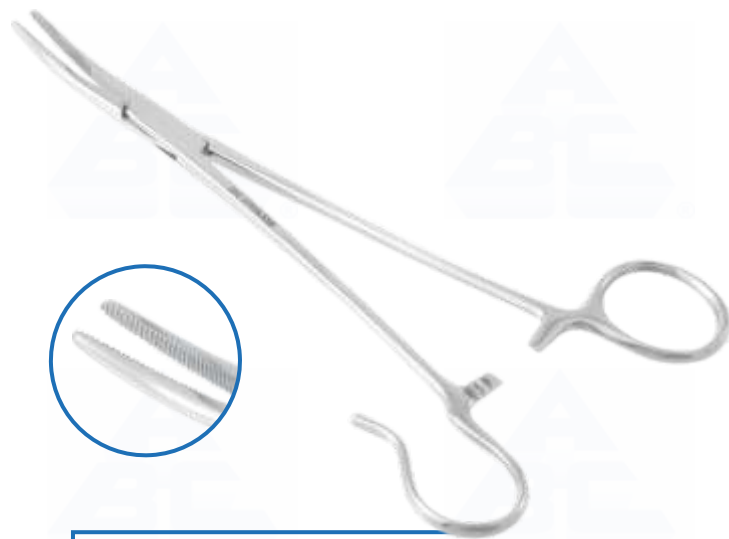

**COD. 0381 - SCHIMIDT 18 cm CURVA
P/ AMIGDALAS**

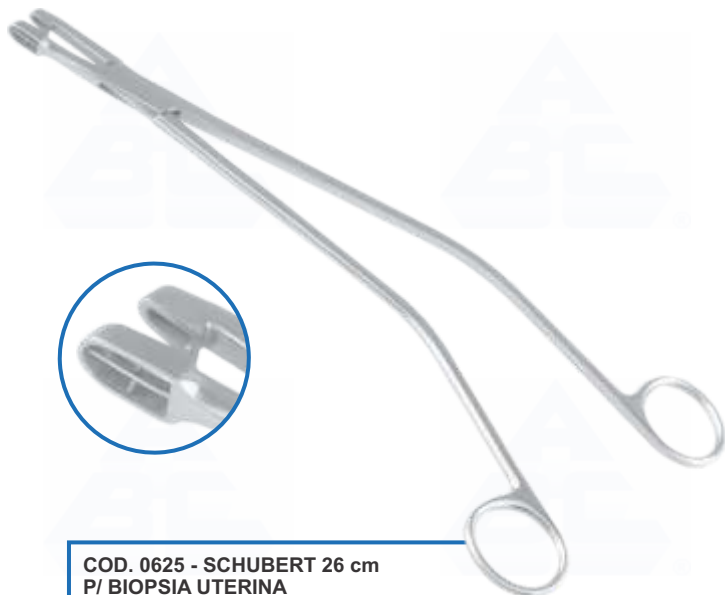

**COD. 0625 - SCHUBERT 26 cm
P/ BIOPSIA UTERINA**



**COD. 0625 - SCHUBERT 26 cm
P/ BIOPSIA UTERINA**



COD. 0404 - SEMB P/ ORTOPEDIA 20 cm



COD. 0458 - SNELLEN DIREITA 9 cm P/ ENTROPIO

PINÇAS

FORCEPS

PINZAS



COD. 0459 - SNELEN ESQUERDA 9 cm P/ ENTROPIO



COD. 0589 - TAKAHASHI 19 cm BOCA RETA P/ NARIZ



COD. 0590 - TAKAHASHI 19 cm BOCA P/ CIMA P/ NARIZ



COD. 0286 - THOMAS GAYLOR 24 cm P/ BIOPSIA



COD. 0522 - TROELTSCH 16 cm P/ CURATIVO AURICULAR
 COD. 0523 - TROELTSCH 18 cm P/ CURATIVO AURICULAR

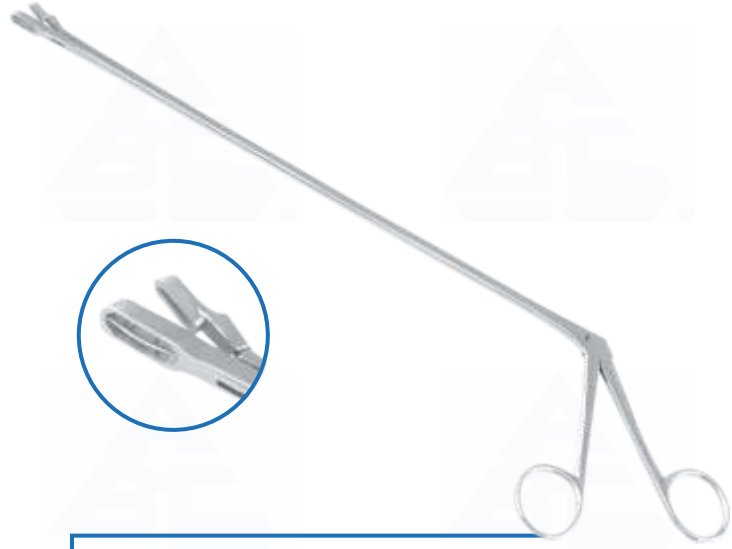

COD. 0621 - YEOMAN 28 cm BOCA ARREDONDADA P/ BIOPSIA
 COD. 0622 - YEOMAN 35 cm BOCA ARREDONDADA P/ BIOPSIA

PINÇAS

FORCEPS

PINZAS



COD. 0623 - YEOMAN 28 cm BOCA ARREDONDADA P/ BIOPSIA
 COD. 0624 - YEOMAN 35 cm BOCA ARREDONDADA P/ BIOPSIA



COD. 0388 - WERTHEIM-CULLEN 22 cm P/ HISTERECTOMIA

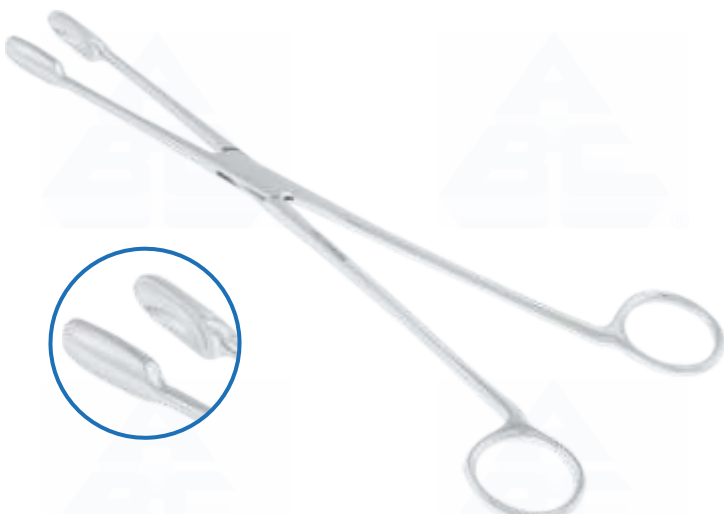

COD. 0984 - WINTER 27 cm RETA Nº 1 P/ ABORTO E PLACENTA
 COD. 0287 - WINTER 27 cm RETA Nº 2 P/ ABORTO E PLACENTA
 COD. 0986 - WINTER 27 cm RETA Nº 3 P/ ABORTO E PLACENTA



COD. 0985 - WINTER 27 cm CURVA Nº 1 P/ ABORTO E PLACENTA
 COD. 0288 - WINTER 27 cm CURVA Nº 2 P/ ABORTO E PLACENTA
 COD. 0987 - WINTER 27 cm CURVA Nº 3 P/ ABORTO E PLACENTA

PORTA - AGULHAS

NEEDLE - HOLDERS

PORTA - AGUJAS



COD. 0449 - CASTROVIEJO 14 cm RETO COM TRAVA



COD. 0450 - CASTROVIEJO 15 cm RETO SEM TRAVA

PORTA - AGULHAS

NEEDLE - HOLDERS

PORTA - AGUJAS



COD. 0451 - CASTROVIEJO 14 cm CURVO COM TRAVA



COD. 0452 - CASTROVIEJO 15 cm CURVO SEM TRAVA



COD. 0289 - CRILE WOOD 15 cm P/ SUTURA
COD. 1050 - CRILE WOOD 16 cm P/ SUTURA
COD. 0290 - CRILE WOOD 18 cm P/ SUTURA



COD. 0291 - DERF 12 cm P/ SUTURA



COD. 0292 - ERMOLD 20 cm P/ USO VETERINARIO



COD. 1154 - MATHIEU 11 cm P/ SUTURA
COD. 0293 - MATHIEU 14 cm P/ SUTURA
COD. 0294 - MATHIEU 17 cm P/ SUTURA
COD. 0295 - MATHIEU 20 cm P/ SUTURA

PORTA - AGULHAS

NEEDLE - HOLDERS

PORTA - AGUJAS



- COD. 0296 - MAYO HEGAR 14 cm P/ SUTURA
- COD. 1048 - MAYO HEGAR 15 cm P/ SUTURA
- COD. 0530 - MAYO HEGAR 16 cm P/ SUTURA
- COD. 0297 - MAYO HEGAR 18 cm P/ SUTURA
- COD. 0298 - MAYO HEGAR 20 cm P/ SUTURA
- COD. 0070 - MAYO HEGAR 25 cm P/ SUTURA
- COD. 1157 - MAYO HEGAR 30 cm P/ SUTURA



- COD. 0930 - PORTA AGULHA P/ FIO DE AÇO 16 cm
- COD. 0931 - PORTA AGULHA P/ FIO DE AÇO 20 cm

PORTA - AGULHAS DE TUNGSTÊNIO

NEEDLE - HOLDERS TUNGSTEN CARBIDE

PORTA - AGUJAS CARBURO DE TUNGSTENO

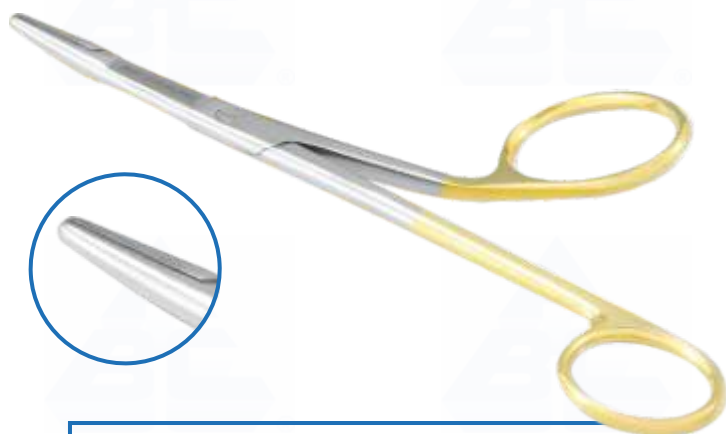

- COD. 0573 - GILLIES 16 cm C/ WIDIA P/ SUTURA



- COD. 0359 - MAYO HEGAR 12 cm C/ WIDIA P/ SUTURA
- COD. 0360 - MAYO HEGAR 14 cm C/ WIDIA P/ SUTURA
- COD. 0361 - MAYO HEGAR 16 cm C/ WIDIA P/ SUTURA
- COD. 0362 - MAYO HEGAR 18 cm C/ WIDIA P/ SUTURA
- COD. 0363 - MAYO HEGAR 20 cm C/ WIDIA P/ SUTURA



- COD. 0574 - MATHIEU 14 cm C/ WIDIA P/ SUTURA
- COD. 0575 - MATHIEU 17 cm C/ WIDIA P/ SUTURA
- COD. 0576 - MATHIEU 20 cm C/ WIDIA P/ SUTURA



- COD. 0572 - OLSEN HEGAR 14 cm C/ WIDIA P/ SUTURA

PORTA GILETE

RAZOR BLADE HOLDERS

PORTA HOJAS DE AFEITAR

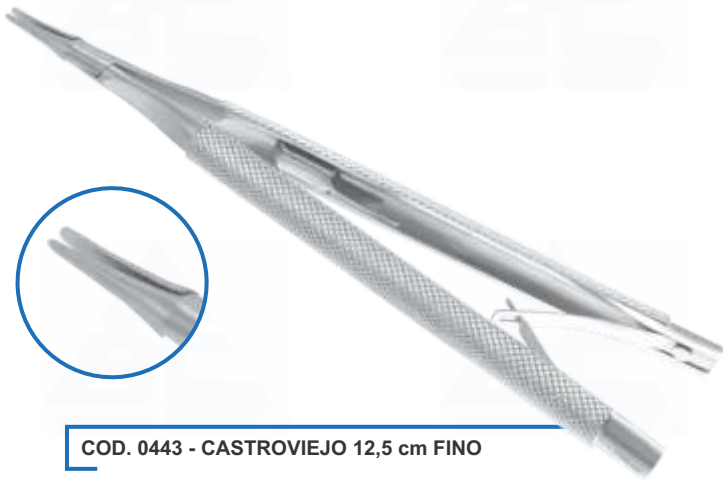

COD. 0443 - CASTROVIEJO 12,5 cm FINO

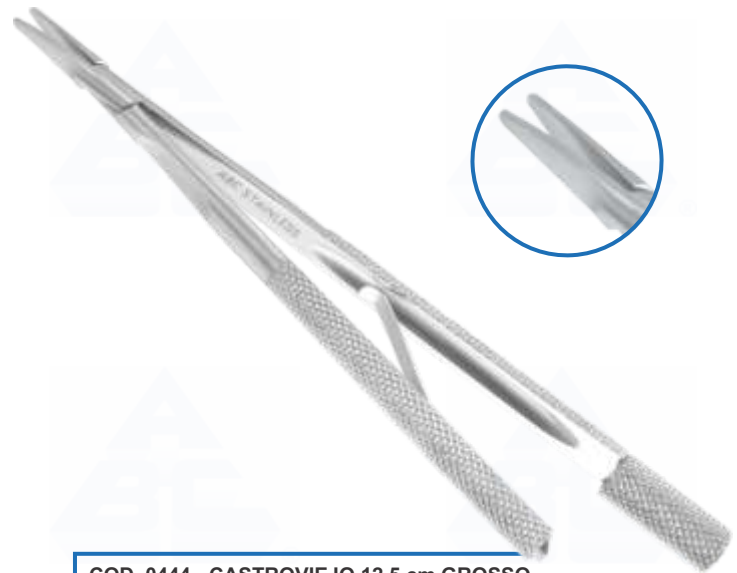

COD. 0444 - CASTROVIEJO 12,5 cm GROSSO

PUNCH

PUNCH

INSTRUMENTAL PARA BIOPSIA DE PELE



COD. 0415 - KEYS 2 mm P/ BIOPSIA DE PELE
COD. 0416 - KEYS 3 mm P/ BIOPSIA DE PELE
COD. 0417 - KEYS 4 mm P/ BIOPSIA DE PELE
COD. 0418 - KEYS 5 mm P/ BIOPSIA DE PELE
COD. 0419 - KEYS 6 mm P/ BIOPSIA DE PELE
COD. 0420 - KEYS 7 mm P/ BIOPSIA DE PELE
COD. 0421 - KEYS 8 mm P/ BIOPSIA DE PELE

RASPAS

NASAL RASPS

ESCOFINAS NASALES



COD. 0926 - AUFRICHT 21 cm DENTES P/ CIMA P/ PLÁSTICA NASAL



COD. 0927 - AUFRICHT 21 cm DENTES P/ BAIXO P/ PLÁSTICA NASAL



COD. 0925 - COTTLE 21 cm P/ PLÁSTICA NASAL

RASPAS

NASAL RASPS

ESCOFINAS NASALES



**COD. 0928 - LEWIS 18 cm DENTE FINO
P/ PLÁSTICA NASAL**



**COD. 0929 - LEWIS 18 cm DENTE GROSSO
P/ PLÁSTICA NASAL**

RETOSCÓPIO

RECTAL SPECULA

ESPÉCULO RECTAL



**COD. 1055 - PITANGA Nº1 (19 X 155 mm)
COD. 1056 - PITANGA Nº2 (22 X 155 mm)
COD. 1057 - PITANGA Nº3 (25 X 155 mm)**

ROTATIVA

UTERINE BIOPSY CURETTES

CURETA DE BIOPSIA UTERINA



COD. 0037 - BALIU 18 cm P/ BIOPSIA UTERINA

RUGINAS

PERIOSTEAL RASPATORIES

LEGRAS - PERIOSTÓTOMOS



COD. 1120 - DOYEN 17 cm DIREITA



COD. 1121 - DOYEN 17 cm ESQUERDA

RUGINAS

PERIOSTEAL RASPATORIES

LEGRAS - PERIOSTÓTOMOS



COD. 0299 - FARABEU 14 cm RETA
P/ CIRURGIA ÓSSEA



COD. 0300 - FARABEU 14 cm CURVA
P/ CIRURGIA ÓSSEA



COD. 0400 - LAMBOTTE 15 cm
P/ CIRURGIA ÓSSEA
COD. 0401 - LAMBOTTE 20 cm
P/ CIRURGIA ÓSSEA

SACA - FIBROMA

MYOMA SCREW

TIRABUZÓN PARA FIBROMA



COD. 0301 - DOYEN 17 cm C/ ESPESSURA 3 mm

SERRAS

SAWS

SIERRA



COD. 0908 - CHARRIERE 30 cm P/ AMPUTAÇÃO



COD. 0440 - GIGLI 30 cm P/ AMPUTAÇÃO
COD. 0441 - GIGLI 40 cm P/ AMPUTAÇÃO
COD. 0442 - GIGLI 50 cm P/ AMPUTAÇÃO

SERRAS

SAWS

SIERRA

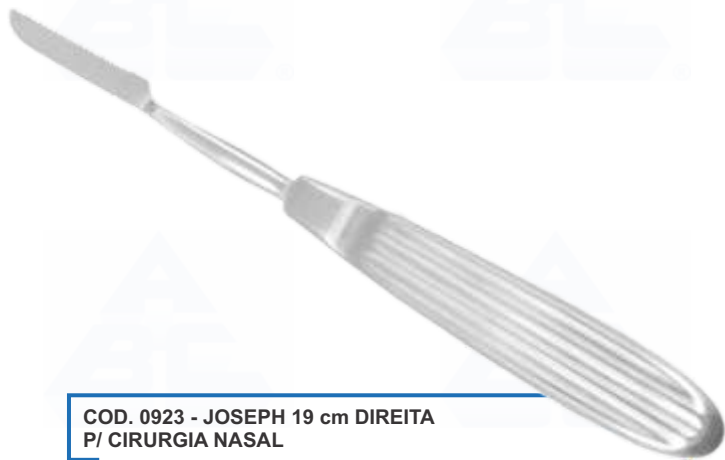

COD. 0923 - JOSEPH 19 cm DIREITA
P/ CIRURGIA NASAL



COD. 0924 - JOSEPH 19 cm ESQUERDA
P/ CIRURGIA NASAL



COD. 0909 - LANGENBECK 23 cm P/ CIRURGIA ÓSSEA



COD. 1051 - MATHIEU 20 cm C/ 3 LAMINAS P/ AMPUTAÇÃO
COD. 0304 - MATHIEU 33 cm C/ 3 LAMINAS P/ AMPUTAÇÃO



COD. 0305 - WEISS 25 cm P/ AMPUTAÇÃO



COD. 0907 - WIGMORE 19 cm P/ GESSO

SERRA - NO

KNOT SAW

SIERRA NUDO

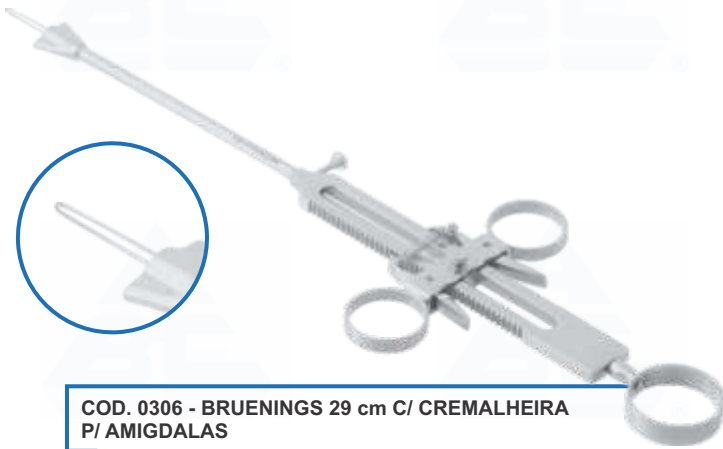

COD. 0306 - BRUENINGS 29 cm C/ CREMALHEIRA P/ AMIGDALAS

SONDAS

PROBES

SONDAS

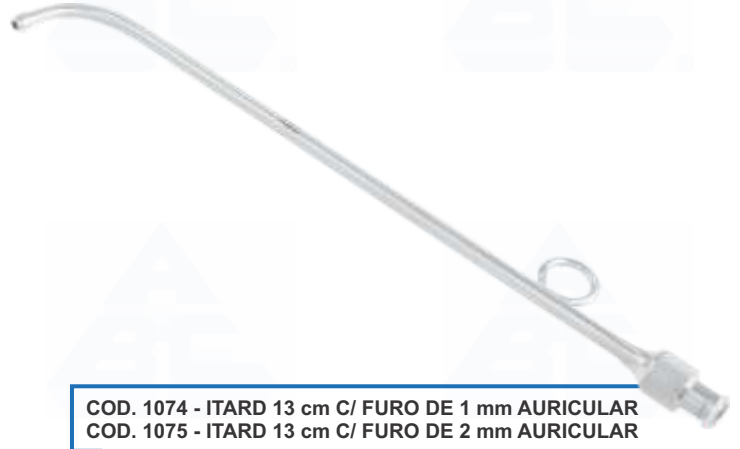

**COD. 1074 - ITARD 13 cm C/ FURO DE 1 mm AURICULAR
COD. 1075 - ITARD 13 cm C/ FURO DE 2 mm AURICULAR**



**COD. 0308 - TENTACANULA 15 cm
SONDA ACANELADA**

TESOURAS

SCISSORS

TIJERAS



COD. 0038 - BALIU 20 cm UTERINA



**COD. 1073 - BARRAQUER 5,5 cm
C/ PONTA ANGULO 7 mm**

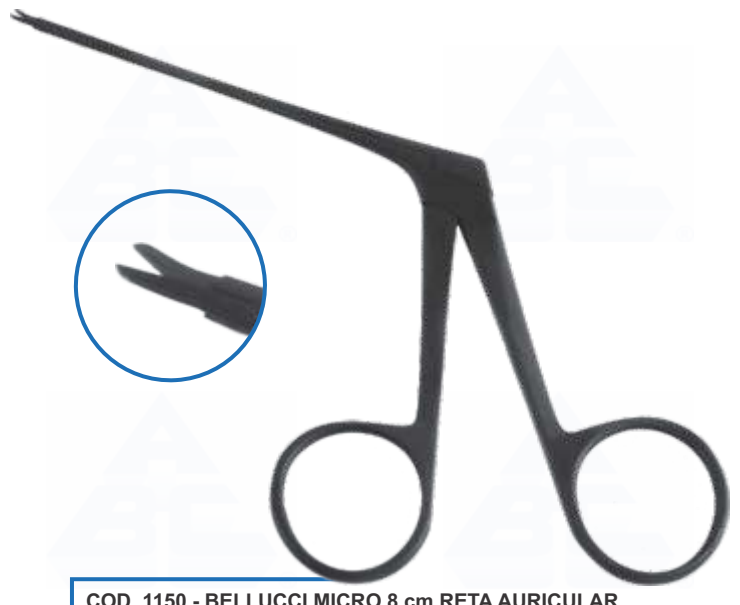

COD. 1150 - BELLUCCI MICRO 8 cm RETA AURICULAR

TESOURAS

SCISSORS

TIJERAS



COD. 1151 - BELLUCCI MICRO 8 cm
CURVA P/ CIMA AURICULAR

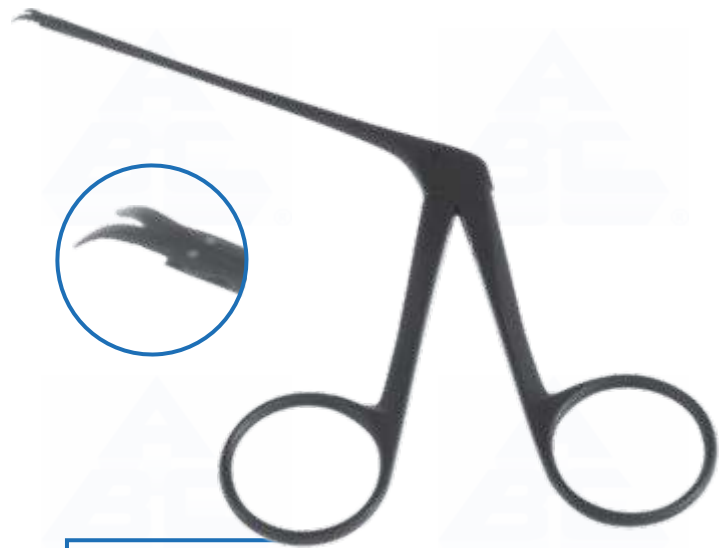

COD. 1152 - BELLUCCI MICRO 8 cm
CURVA P/ DIREITA AURICULAR



COD. 1153 - BELLUCCI MICRO 8 cm
CURVA P/ ESQUERDA AURICULAR



COD. 0446 - CASTROVIEJO 9 cm CURVA
P/ MICRO CIRURGIA



COD. 0309 - CIRÚRGICA 15 cm RETA FINA/FINA
COD. 0315 - CIRÚRGICA 17 cm RETA FINA/FINA



COD. 0312 - CIRÚRGICA 15 cm CURVA FINA/FINA
COD. 0318 - CIRÚRGICA 17 cm CURVA FINA/FINA

TESOURAS

SCISSORS

TIJERAS



COD. 0311 - CIRÚRGICA 15 cm RETA ROMBA/ROMBA
COD. 0317 - CIRÚRGICA 17 cm RETA ROMBA/ROMBA



COD. 0314 - CIRÚRGICA 15 cm CURVA ROMBA/ROMBA
COD. 0320 - CIRÚRGICA 17 cm CURVA ROMBA/ROMBA



COD. 0310 - CIRÚRGICA 15 cm RETA FINA/ROMBA
COD. 0316 - CIRÚRGICA 17 cm RETA FINA/ROMBA



COD. 0313 - CIRÚRGICA 15 cm CURVA FINA/ROMBA
COD. 0319 - CIRÚRGICA 17 cm CURVA FINA/ROMBA



COD. 0899 - ENTEROTOMO 21 cm
P/ ANATOMIA E ENTEROTOMIA



COD. 0645 - GOLDMAN FOX 13 cm SERRILHADA
P/ PERIODONTIA

TESOURAS

SCISSORS

TIJERAS



COD. 0567 - HEYMANN ANGULADA 18 cm C/ SERRILHA P/ CIRURGIA NASAL



COD. 0897 - IRIS OU GENGIVA RETA 8 cm
COD. 0321 - IRIS OU GENGIVA RETA 12 cm



COD. 0898 - IRIS OU GENGIVA CURVA 8 cm
COD. 0322 - IRIS OU GENGIVA CURVA 12 cm



COD. 0391 - JOSEPH 14 cm RETA P/ USO GERAL



COD. 0392 - JOSEPH 14 cm CURVA P/ USO GERAL



COD. 0641 - KILNER 12 cm P/ CIRURGIA PLÁSTICA

TESOURAS

SCISSORS

TIJERAS



COD. 0323 - LISTER 14 cm P/ BANDAGEM
 COD. 0324 - LISTER 17 cm P/ BANDAGEM
 COD. 0325 - LISTER 19 cm P/ BANDAGEM



COD. 0991 - MAYO STILLE 15 cm RETA C/ SERRILHA
 P/ CARTILAGEM



COD. 0326 - MAYO STILLE 15 cm RETA
 COD. 0328 - MAYO STILLE 17 cm RETA
 COD. 0389 - MAYO STILLE 19 cm RETA



COD. 0326 - MAYO STILLE 15 cm CURVA
 COD. 0328 - MAYO STILLE 17 cm CURVA
 COD. 0389 - MAYO STILLE 19 cm CURVA



COD. 0330 - METZEMBAUM 12 cm RETA
 COD. 0332 - METZEMBAUM 15 cm RETA
 COD. 0334 - METZEMBAUM 18 cm RETA
 COD. 0336 - METZEMBAUM 20 cm RETA
 COD. 0338 - METZEMBAUM 25 cm RETA
 COD. 0892 - METZEMBAUM 28 cm RETA
 COD. 0894 - METZEMBAUM 30 cm RETA



COD. 0331 - METZEMBAUM 12 cm CURVA
 COD. 0333 - METZEMBAUM 15 cm CURVA
 COD. 0335 - METZEMBAUM 18 cm CURVA
 COD. 0337 - METZEMBAUM 20 cm CURVA
 COD. 0339 - METZEMBAUM 25 cm CURVA
 COD. 0893 - METZEMBAUM 28 cm CURVA
 COD. 0895 - METZEMBAUM 30 cm CURVA

TESOURAS

SCISSORS

TIJERAS



**COD. 0456 - NOYES IRIS 12 cm RETA
P/ MICRO CIRURGIA**



**COD. 0457 - NOYES IRIS 12 cm CURVA
P/ MICRO CIRURGIA**



COD. 0340 - OURO RETA 10 cm P/ CORTE METAL



COD. 0341 - OURO CURVA 10 cm P/ CORTE METAL



**COD. 0642 - POTTS - SMITH 19 cm 25°
P/ VASCULAR**



**COD. 0643 - POTTS - SMITH 19 cm 40°
P/ VASCULAR**

TESOURAS

SCISSORS

TIJERAS



COD. 0644 - POTTS - SMITH 19 cm 60°
P/ VASCULAR



COD. 1155 - SCHUMACHER 15,5 cm
P/ CORDÃO UMBILICAL



COD. 0342 - SIMS 20 cm RETA UTERINA



COD. 0343 - SIMS 20 cm CURVA UTERINA



COD. 0889 - SMITH 20 cm P/ BANDAGEM



COD. 0344 - SPENCER 9 cm RETA P/ RETIRAR PONTOS
COD. 0646 - SPENCER 12 cm RETA P/ RETIRAR PONTOS

TESOURAS

SCISSORS

TIJERAS

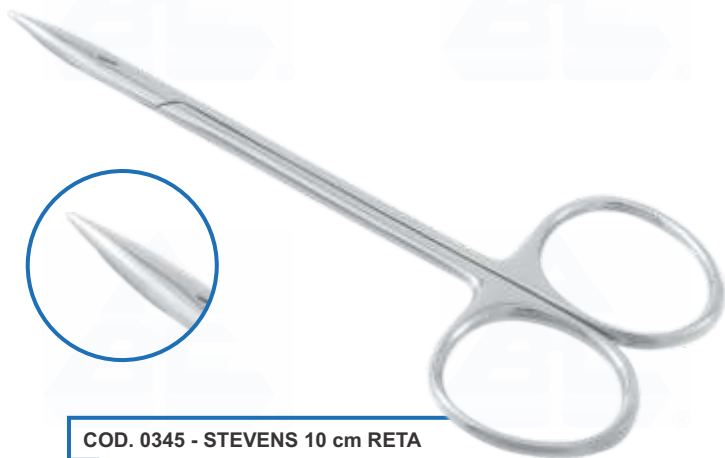

COD. 0345 - STEVENS 10 cm RETA



COD. 0346 - STEVENS 10 cm CURVA



COD. 0896 - TESOURA P/ CORDÃO UMBILICAL 10 cm
MODELO U.S.A.



COD. 0447 - VANNAS 8 cm RETA P/ MICRO CIRURGIA



COD. 0448 - VANNAS 8 cm CURVA P/ MICRO CIRURGIA



COD. 0454 - WESTCOTT 11 cm RETA P/ MICRO CIRURGIA

TESOURAS

SCISSORS

TIJERAS

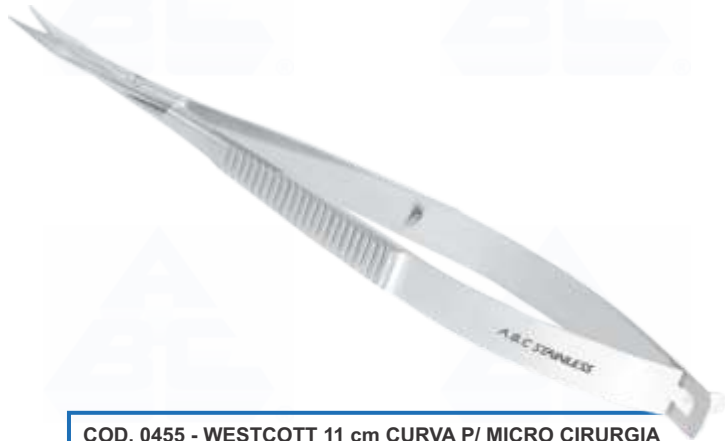

COD. 0455 - WESTCOTT 11 cm CURVA P/ MICRO CIRURGIA

VALVULAS

VALVES

VALVULAS



COD. 0350 - AUVARD C/ PESO 38 X 80 P/ GINECOLOGIA



COD. 0352 - DOYEN 45 X 60 cm P/ GINECOLOGIA
 COD. 0353 - DOYEN 45 X 90 cm P/ GINECOLOGIA
 COD. 0354 - DOYEN 45 X 120 cm P/ GINECOLOGIA
 COD. 0605 - DOYEN 60 X 60 cm P/ GINECOLOGIA
 COD. 0606 - DOYEN 60 X 90 cm P/ GINECOLOGIA
 COD. 0607 - DOYEN 60 X 120 cm P/ GINECOLOGIA



COD. 0351 - DOYEN SUB-PUBIANA



COD. 0355 - VALVULA P/ AFASTADOR BAUFOR
 ABDOMINAL CURVA 45 X 80



COD. 0977 - VALVULA P/ AFASTADOR BAUFOR
 ABDOMINAL RETA 70 X 100



INSTRUMENTOS CIRÚRGICOS

ABC INSTRUMENTOS CIRÚRGICOS LTDA.

Estrada Das Lágrimas, 3346 / 3350

São Paulo - SP - CEP: 04244-000

Tel/Fax: +55 11 2353-4000

abc@abcinstrumentos.com.br

www.abcinstrumentos.com.br